

Sliding Tokens on a Cactus*

Duc A. Hoang¹ and Ryuhei Uehara²

- 1 Japan Advanced Institute of Science and Technology, Japan
hoanganhduc@jaist.ac.jp
- 2 Japan Advanced Institute of Science and Technology, Japan
uehara@jaist.ac.jp

Abstract

Given two independent sets \mathbf{I} and \mathbf{J} of a graph G , imagine that a token (coin) is placed on each vertex in \mathbf{I} . Then, the SLIDING TOKEN problem asks if one could transform \mathbf{I} to \mathbf{J} using a sequence of elementary steps, where each step requires sliding a token from one vertex to one of its neighbors, such that the resulting set of vertices where tokens are placed still remains independent. In this paper, we describe a polynomial-time algorithm for solving SLIDING TOKEN in case the graph G is a cactus. Our algorithm is designed based on two observations. First, all structures that forbid the existence of a sequence of token slidings between \mathbf{I} and \mathbf{J} , if exist, can be found in polynomial time. A NO-instance may be easily deduced using this characterization. Second, without such forbidden structures, a sequence of token slidings between \mathbf{I} and \mathbf{J} does exist.

1998 ACM Subject Classification G.2.2 Graph algorithms

Keywords and phrases reconfiguration problem, token sliding, independent set, cactus

Digital Object Identifier 10.4230/LIPIcs.ISAAC.2016.37

1 Introduction

A reconfiguration problem arises when we wish to find a step-by-step transformation between two feasible solutions of a problem. In each transformation, each intermediate result is also feasible, and each transformation step abides by a fixed reconfiguration rule. The *reconfiguration problems* attract the attention recently from the viewpoint of theoretical computer science, and have been studied extensively for several well-known problems, including SATISFIABILITY [8, 12], INDEPENDENT SET [9, 10, 11, 14], SET COVER, CLIQUE, MATCHING [10], and so on. For an overview of this research area, we refer the readers to [17].

Although the problems above might seem to be artificial, from the viewpoint of recreational mathematics, the reconfiguration problems have already been played long time, and partially well investigated. One of the most famous classic examples is the so-called *15 puzzle* (see Figure 1). If rectangles are allowed, we obtain a more general classic puzzle called “sliding block puzzle” and its variants (see Figure 1). In 1964, Gardner said that “These puzzles are very much in want of a theory” [7]. After 40 years, Hearn and Demaine gave the theory. Using their proposed *non-deterministic constraint logic* model [9], they proved that the general sliding block puzzle is PSPACE-complete, while it is linear time solvable if all pieces are unit squares. We remind that finding an optimal solution is NP-complete for YES-instance of this linear time solvable case. In this way, we can characterize three

* This work was partially supported by MEXT/JSPS Kakenhi (Grant Numbers 26330009 and 24106004).



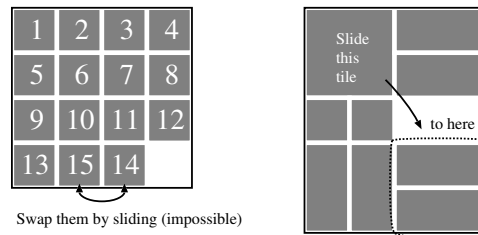

■ **Figure 1** The 15 puzzle and sliding block puzzle.

familiar complexity classes P, NP, and PSPACE using the model of the sliding block puzzle, a representative reconfiguration problem.

From the viewpoint of theoretical computer science, one of the most important problems is the 3SAT. Even in the reconfiguration problem, the computational complexity of the 3SAT has been investigated, and it is shown to be PSPACE-complete [8]. Recently, for the 3SAT, an interesting trichotomy for the complexity of finding a shortest sequence has been shown; that is, for the reconfiguration problem, finding a shortest sequence between two satisfiable assignments is in P, NP-complete, or PSPACE-complete in certain conditions [13]. In general, the reconfiguration problems tend to be PSPACE-complete, and some polynomial time algorithms are shown in restricted cases. However, we have to mind that it may potentially have different computational complexity for deciding two configurations are reconfigurable, for finding a sequence of feasible solutions between two configurations, or for finding a shortest sequence of feasible solutions between two configurations. Especially, since some problems are PSPACE-complete, we may have some case that the length of the sequence of solutions can be super-polynomial even if the decision problem is in NP.

Beside the 3SAT, one of the most important problems in theoretical computer science is the INDEPENDENT SET problem. For this notion, the natural reconfiguration problem is called the SLIDING TOKEN problem introduced by Hearn and Demaine [9]: Suppose that we are given two independent sets \mathbf{I} and \mathbf{J} of a graph $G = (V, E)$ and imagine that a token (or coin) is placed on each vertex in \mathbf{I} . Then, the SLIDING TOKEN problem asks if there exists a sequence $\mathcal{S} = \langle \mathbf{I}_1, \mathbf{I}_2, \dots, \mathbf{I}_\ell \rangle$ of independent sets of G such that (a) $\mathbf{I}_1 = \mathbf{I}$, $\mathbf{I}_\ell = \mathbf{J}$, and $|\mathbf{I}| = |\mathbf{I}_i|$ for all i with $1 \leq i \leq \ell$; and (b) for each i , $2 \leq i \leq \ell$, there is an edge uv in E such that $\mathbf{I}_{i-1} \setminus \mathbf{I}_i = \{u\}$ and $\mathbf{I}_i \setminus \mathbf{I}_{i-1} = \{v\}$. If such a sequence \mathcal{S} exists, we call \mathcal{S} a *TS-sequence* and say that \mathcal{S} *reconfigures* \mathbf{I} to \mathbf{J} in G and write $\mathbf{I} \rightsquigarrow^G \mathbf{J}$. Figure 2 illustrates a sequence $\langle \mathbf{I}_1, \mathbf{I}_2, \dots, \mathbf{I}_5 \rangle$ of independent sets which reconfigures $\mathbf{I} = \mathbf{I}_1$ into $\mathbf{J} = \mathbf{I}_5$. Hearn and Demaine proved that the SLIDING TOKEN problem is PSPACE-complete for planar graphs as an example of the application of their nondeterministic constraint logic model, which can be used to prove PSPACE-hardness of many puzzles and games [9]. (We note that the reconfiguration problem for INDEPENDENT SET has some variants. In [11], the reconfiguration problem for INDEPENDENT SET is studied under three reconfiguration rules called “token sliding,” “token jumping,” and “token addition and removal.” In this paper, we only consider the token sliding model, and see [11] for the other models.)

For the SLIDING TOKEN problem, some polynomial-time algorithms have been shown recently for bipartite permutation graphs [6] and claw-free graphs [2]. Linear-time algorithms have been shown for cographs [11] and trees [4]. Even a shortest TS-sequence can be found in polynomial time for a caterpillar [18]. On the other hand, PSPACE-completeness is also shown for graphs of bounded tree-width [15] and planar graphs [9]. Recently, hardness results for split graphs, and polynomial-time algorithm for interval graphs have been announced by Bonamy and Bousquet [1].

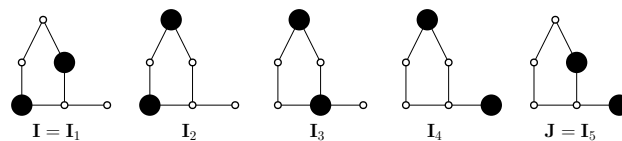

■ **Figure 2** A sequence $(\mathbf{I}_1, \mathbf{I}_2, \dots, \mathbf{I}_5)$ of independent sets of the same graph, where the vertices in independent sets are depicted by black circles (tokens).

In this paper, we give a polynomial-time algorithm for the SLIDING TOKEN problem for a cactus. Intuitively, a cactus is a graph that is obtained by joining cycles. When we solve the SLIDING TOKEN problem, there are three major points to be considered. First, we have to decide a correspondence between the tokens in \mathbf{I} and \mathbf{J} . That is, we have to decide the goal in \mathbf{J} for each token in \mathbf{I} , which is called *target-assignments*. Next, we design the route for each token. In some graph class, say, a tree, the second one is easy since any pair of vertices on a tree has unique path for joining them. However, even in this case, some token is required to make “detours” to open its position to admit other tokens to go through its neighbors (see [18] for the details). When the graph contains a cycle, since the route for a token is not unique any more, we have to “choose” the route. Therefore, for each token, we may have exponentially many choices and possibly super polynomial detours in general. Especially, if a graph contains an odd cycle, the SLIDING TOKEN problem is quite difficult.

The idea of our algorithm is to characterize all structures that forbid the existence of a TS-sequence between \mathbf{I} and \mathbf{J} first, and then prove the existence of a TS-sequence between them when no such forbidden structures exist. A trivial forbidden structure is clearly the sizes of \mathbf{I} and \mathbf{J} , i.e., if $|\mathbf{I}| \neq |\mathbf{J}|$ then \mathbf{I} cannot be reconfigured to \mathbf{J} (and vice versa) using TS rule. In case of cacti, two more forbidden structures, named *rigid token* and *confined cycle*, are characterized (see Section 4). We claim that these structures (if exist) can be found in polynomial time. For a cactus that does not contain these forbidden structures, we show that a TS-sequence between \mathbf{I} and \mathbf{J} exists (Lemma 16). Despite of the non-trivial tasks of identifying forbidden structures and designing reconfiguration sequences, this technique was proved to be powerful for developing polynomial-time algorithms for solving several reconfiguration problems [3, 4, 6, 16].

In this paper, some proof details are omitted due to the space restriction. For the statements marked with (*), one can find the corresponding proof details in the appendix.

2 Preliminaries

In this section, we define some notions that will be used in this paper. For the notions which are not mentioned here, the readers are referred to [5].

Let G be a graph with vertex set $V(G)$ and edge set $E(G)$. For a vertex v , let $N_G(v)$ be the set of all neighbors of v in G . Let $N_G[v] = N_G(v) \cup \{v\}$ and $\deg_G(v) = |N_G(v)|$. For a subset $X \subseteq V(G)$, we simply write $N_G[X] = \bigcup_{v \in X} N_G[v]$. For two vertices u, v , denote by $\text{dist}_G(u, v)$ the length of a shortest uv -path in G . G is *connected* if any pair of vertices in G are joined by at least one path; otherwise, we say that G is *disconnected*. For $X \subseteq V(G)$, denote by $G[X]$ the subgraph of G induced by vertices of X . We write $G - X$ to indicate the graph $G[V(G) \setminus X]$. Similarly, for a subgraph H of G , we denote by $G - H$ the graph $G[V(G) \setminus V(H)]$, and we say that the graph $G - H$ is obtained by *removing H from G* . An *independent set* \mathbf{I} of a graph G is a subset of $V(G)$ in which for every $u, v \in \mathbf{I}$, uv is not an edge of G . For a subgraph H of G , sometimes we write $\mathbf{I} \cap H$ and $\mathbf{I} - H$ to indicate the

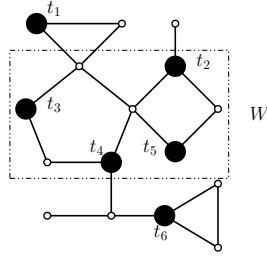

■ **Figure 3** The tokens t_3 and t_5 are (G, \mathbf{I}, W) -confined, while t_2 and t_4 are not.

sets $\mathbf{I} \cap V(H)$ and $\mathbf{I} \setminus V(H)$, respectively. A vertex v of G is called a *cut vertex* if $G - v$ is disconnected; otherwise, we say that v is a *non-cut vertex*. A *block* of G is a maximal connected subgraph (i.e., a subgraph with as many edges as possible) with no cut vertex. G is called a *cactus* if every block of G is either K_2 or a simple cycle.

Let G be a graph and \mathbf{I} an independent set of G . For a TS-sequence \mathcal{S} , we write $\mathbf{I} \in \mathcal{S}$ if \mathbf{I} appears in \mathcal{S} . We say that \mathcal{S} *involves* a vertex v if there exists some independent set $\mathbf{I} \in \mathcal{S}$ such that $v \in \mathbf{I}$. We say that $\mathcal{S} = \langle \mathbf{I}_1, \mathbf{I}_2, \dots, \mathbf{I}_\ell \rangle$ *slides* (or *moves*) the token t placed at $u \in \mathbf{I}_1$ to $v \notin \mathbf{I}_1$ in G if after applying the sliding steps described in \mathcal{S} , the token t is placed at $v \in \mathbf{I}_\ell$. Observe that a TS-sequence is *reversible*, i.e., $\mathbf{I} \overset{G}{\rightsquigarrow} \mathbf{J}$ if and only if $\mathbf{J} \overset{G}{\rightsquigarrow} \mathbf{I}$. The *length* of a TS-sequence \mathcal{S} is defined as the number of independent sets contained in \mathcal{S} .

One of the non-trivial structures that forbid the existence of a TS-sequence between any two independent sets of a graph is the so-called *rigid token*. Let $u \in \mathbf{I}$ be a vertex of G . The token t placed at u is called (G, \mathbf{I}) -*rigid* if for any \mathbf{J} such that $\mathbf{I} \overset{G}{\rightsquigarrow} \mathbf{J}$, $u \in \mathbf{J}$. The set of vertices where (G, \mathbf{I}) -rigid tokens are placed is denoted by $\mathcal{R}(G, \mathbf{I})$. If t is not (G, \mathbf{I}) -rigid, we say that it is (G, \mathbf{I}) -*movable*. Decide if a token is (G, \mathbf{I}) -rigid is PSPACE-complete for a general graph G [6].

Naturally, one can generalize the notion of rigid tokens in the following way. Let $W \subseteq V(G)$ be a subset of vertices of G . We say that t is (G, \mathbf{I}, W) -*confined* if for every \mathbf{J} such that $\mathbf{I} \overset{G}{\rightsquigarrow} \mathbf{J}$, t is always placed at some vertex of W (see Figure 3). In other words, t can only be slid along edges of $G[W]$. Observe that a token t placed at some vertex $u \in \mathbf{I}$ is (G, \mathbf{I}) -rigid if and only if it is $(G, \mathbf{I}, \{u\})$ -confined.

Let H be an induced subgraph of G . H is called (G, \mathbf{I}) -*confined* if $\mathbf{I} \cap H$ is a maximum independent set of H and all tokens in $\mathbf{I} \cap H$ are $(G, \mathbf{I}, V(H))$ -confined. In particular, if H is a cycle (resp. a path) of G , we say that it is a (G, \mathbf{I}) -*confined cycle* (resp. (G, \mathbf{I}) -*confined path*). We denote by $\mathcal{C}(G, \mathbf{I})$ the set of all (G, \mathbf{I}) -confined cycles of G . We will see later that (G, \mathbf{I}) -confined cycles indeed form a structure that forbids the existence of a TS-sequence when G is a cactus. For a vertex $v \in V(H)$, we define G_H^v to be the (connected) component of G_H containing v , where G_H is obtained from G by removing all edges of H . Observe that if G is a cactus then for a cycle H of G and two distinct vertices $u, v \in V(H)$, $V(G_H^u) \cap V(G_H^v) = \emptyset$.

3 Some useful observations

In this section, we prove some useful observations. These observations will be implicitly used in many statements of this paper. The next lemma describes some equivalent conditions of being a (G, \mathbf{I}) -confined induced subgraph, where \mathbf{I} is a given independent set of a graph G . Intuitively, the structure of a (G, \mathbf{I}) -confined induced subgraph H guarantees that the tokens *inside* (resp. *outside*) of H cannot be moved *out* (resp. *in*).

► **Lemma 1** (*). Let \mathbf{I} be an independent set of a graph G . Let H be an induced subgraph of G . Then the following conditions are equivalent.

- (i) H is (G, \mathbf{I}) -confined.
- (ii) For every independent set \mathbf{J} satisfying $\mathbf{I} \overset{G}{\rightsquigarrow} \mathbf{J}$, $\mathbf{J} \cap H$ is a maximum independent set of H .
- (iii) $\mathbf{I} \cap H$ is a maximum independent set of H and for every \mathbf{J} satisfying $\mathbf{I} \overset{G}{\rightsquigarrow} \mathbf{J}$, any token t_x placed at $x \in \mathbf{J} \cap H$ is $(G_H^x, \mathbf{J} \cap G_H^x)$ -rigid.

The next proposition says that if the given graph G is not connected, then one can deal with each component separately.

► **Proposition 2** (*). Let \mathbf{I}, \mathbf{J} be two given independent set of G . Assume that G_1, \dots, G_k are the components of G . Then $\mathbf{I} \overset{G}{\rightsquigarrow} \mathbf{J}$ if and only if $\mathbf{I} \cap G_i \overset{G_i}{\rightsquigarrow} \mathbf{J} \cap G_i$ for $i = 1, 2, \dots, k$.

Thus, when dealing with SLIDING TOKEN, one can assume without loss of generality that the given graph is connected. Next, we claim that in certain conditions, a TS-sequence in a subgraph G' of G can be somehow “extended” to a sequence in G , and vice versa.

► **Proposition 3** (*). Let u be a vertex of a graph G . Let $\mathcal{S} = \langle \mathbf{I}_1, \mathbf{I}_2, \dots, \mathbf{I}_\ell \rangle$ be a TS-sequence in G such that for any $\mathbf{I}_i \in \mathcal{S}$, $u \in \mathbf{I}_i$, where $i \in \{1, 2, \dots, \ell\}$. Let $G' = G - N_G[u]$. Then $\mathbf{I}_1 \cap G' \overset{G'}{\rightsquigarrow} \mathbf{I}_\ell \cap G'$. Moreover, for any TS-sequence $\mathcal{S}' = \langle \mathbf{I}'_1, \dots, \mathbf{I}'_l \rangle$ in G' , $\mathbf{I}'_1 \cup \{u\} \overset{G}{\rightsquigarrow} \mathbf{I}'_l \cup \{u\}$.

Finally, we claim that if $\mathcal{R}(C, \mathbf{I}) = \mathcal{R}(C, \mathbf{J}) = \emptyset$, where C is a cycle and \mathbf{I}, \mathbf{J} are two independent sets of C , then $\mathbf{I} \overset{C}{\rightsquigarrow} \mathbf{J}$ if and only if $|\mathbf{I}| = |\mathbf{J}|$. In particular, if $\mathcal{R}(C, \mathbf{I}) = \emptyset$, starting from a given independent set \mathbf{I} , using token sliding, one can obtain any target independent set \mathbf{J} of the same cardinality.

► **Lemma 4** (*). Let C be a cycle. Let \mathbf{I} and \mathbf{J} be two given independent sets of C . Assume that there are no (C, \mathbf{I}) -rigid and (C, \mathbf{J}) -rigid tokens. Then $\mathbf{I} \overset{C}{\rightsquigarrow} \mathbf{J}$ if and only if $|\mathbf{I}| = |\mathbf{J}|$.

4 The forbidden structures

In this section, we describe two non-trivial structures that forbid the existence of a TS-sequence between any two independent sets of a cactus G . The first structure is the (G, \mathbf{I}) -rigid tokens, i.e., the tokens in \mathbf{I} that cannot be slid along any edge of G .

► **Lemma 5**. Let \mathbf{I} be an independent set of a cactus G . For any vertex $u \in \mathbf{I}$, the token t placed at u is (G, \mathbf{I}) -rigid (see Figure 4(a)) if and only if for every vertex $v \in N_G(u)$, there exists a vertex $w \in (N_G(v) \setminus \{u\}) \cap \mathbf{I}$ satisfying one of the following conditions:

- (i) The token t_w on w is $(G', \mathbf{I} \cap G')$ -rigid, where $G' = G - N_G[u]$.
- (ii) The token t_w on w is $(G', \mathbf{I} \cap G')$ -movable; and there exists a cycle C in G such that $u \notin V(C)$, $\{v, w\} \subseteq V(C)$, and the path $P = C - v$ is $(G', \mathbf{I} \cap G')$ -confined.

Proof. First of all, we show the only-if-part. Let $v \in N_G(u)$. Assume that there exists $w \in (N_G(v) \setminus \{u\}) \cap \mathbf{I}$ such that either (i) or (ii) holds. We claim that in both cases, t cannot be slid to v .

- If (i) holds then clearly there is no TS-sequence in G' which slides t_w to a vertex in $N_{G'}(w) = N_G(w) \setminus \{v\}$. Hence, t cannot be slid to v .

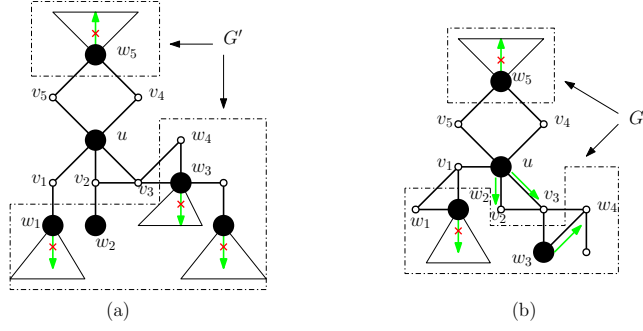

■ **Figure 4** The token placed at $u \in \mathbf{I}$ is (a) (G, \mathbf{I}) -rigid or (b) (G, \mathbf{I}) -movable.

- When (ii) holds. Since t_w is $(G', \mathbf{I} \cap G')$ -movable, it can be (at least) slid in G' to a vertex $x \in N_{G'}(w)$ by some TS-sequence \mathcal{S} . Since P is $(G', \mathbf{I} \cap G')$ -confined, there is no TS-sequence in G' that slides a token from $G' - P$ to P and vice versa. Clearly, this also holds for \mathcal{S} . Let $w' \in N_G(v) \cap V(C)$ such that $w' \neq w$. Hence, if $w' \notin \mathbf{I}$ then before sliding any other token in P , \mathcal{S} must move a token in $N_P(w') \cap \mathbf{I}$ (because $\mathbf{I} \cap P$ is a maximum independent set of P) to w' . Clearly, $N_G(v) \cap \mathbf{I}' \neq \emptyset$ for any \mathbf{I}' such that $\mathbf{I} \cap G' \xrightarrow{G'} \mathbf{I}'$, which means that t cannot be slid to v .

We have shown that if either (i) or (ii) holds, t cannot be slid to v . Since this holds for any $v \in N_G(u)$, it follows that t is (G, \mathbf{I}) -rigid.

Next, we show the if-part. More precisely, we claim that if both (i) and (ii) do not hold, then t is (G, \mathbf{I}) -movable (see Figure 4(b)).

Case 1: There exists $v \in N_G(u)$ such that $(N_G(v) \setminus \{u\}) \cap \mathbf{I} = \emptyset$. Clearly, t can be slid to v and hence is (G, \mathbf{I}) -movable.

Case 2: For all $v \in N_G(u)$, $(N_G(v) \setminus \{u\}) \cap \mathbf{I} \neq \emptyset$. Let $w \in (N_G(v) \setminus \{u\}) \cap \mathbf{I}$. Since (i) does not hold, we can assume that t_w is $(G', \mathbf{I} \cap G')$ -movable. Since (ii) does not hold, for any cycle C of G , (at least) one of the following conditions does not hold: (a) $u \notin V(C)$; (b) $\{v, w\} \subseteq V(C)$; (c) P is (G, \mathbf{I}) -confined. Note that by definition, $w \neq u$. Additionally, since G is a cactus, there is at most one cycle C that contains both v and w . Let $H(G', w)$ be the (connected) component of G' containing w . We claim that for each such w above, one can slide t_w to a vertex in $N_{H(G', w)}(w)$ without sliding another token to a vertex in $N_G(v)$ beforehand. Eventually, there are no tokens in $N_G(v)$ other than t . Consider the following cases:

Case 2-1: Any cycle C contains either v or w but not both of them. Since t_w is (G, \mathbf{I}) -movable, it is also $(H(G', w), \mathbf{I} \cap H(G', w))$ -movable. Assume that there exists a vertex $x \in N_G(v) \cap H(G', w)$, $x \neq w$. Since $H(G', w)$ is connected, there exists a wx -path Q in $H(G', w)$. Note that Q , vw and vx form a cycle in G that contains both v and w , which contradicts our assumption. Hence, $N_G(v) \cap H(G', w) = \{w\}$. Therefore, one can simply slides t_w to a vertex in $N_{H(G', w)}(w)$ without sliding another token to a vertex in $N_G(v)$ beforehand.

Case 2-2: There is a (unique) cycle C that contains both v and w . When $u \in V(C)$ holds. As before, $N_G(v) \cap H(G', w) = \{w\}$. Otherwise, using the same argument as before, we have that the wx -path Q , vw and vx form a cycle C' in G that contains both v and w , where $x \in N_G(v) \cap H(G', w)$ and $x \neq w$. Because Q (a subgraph of G') does not contain u , it follows that $C' \neq C$, which is a contradiction. Since $N_G(v) \cap H(G', w) = \{w\}$, one can simply slides t_w to a vertex in $N_{H(G', w)}(w)$ without sliding another token to a vertex in $N_G(v)$ beforehand.

When $u \notin V(C)$ holds. Let $w' \in N_C(v)$, $w' \neq w$. By definition of a cactus and our assumption, $N_C(v) \cap H(G', w) = \{w, w'\}$. Since $\{v, w\} \subseteq V(C)$, it must happen that the condition (c) does not hold. By Lemma 1, there exists an independent set \mathbf{I}' with $\mathbf{I} \cap G' \overset{G'}{\rightsquigarrow} \mathbf{I}'$ such that $|\mathbf{I} \cap P| < \lfloor k/2 \rfloor$, where $P = C - v$ and k is the length of C . (A maximum independent set of P must be of size $\lfloor k/2 \rfloor$.) Suppose that both w and w' are in \mathbf{I}' . Note that both t_w and $t_{w'}$ are (G', \mathbf{I}') -movable. Let \mathcal{S}_w be a TS-sequence in G' that slides t_w to a vertex $x \in N_{H(G', w)}(w)$. Similarly, let $\mathcal{S}_{w'}$ be a TS-sequence in G' that slides $t_{w'}$ to a vertex $y \in N_{H(G', w)}(w')$. Since $|\mathbf{I}' \cap P| \leq \lfloor k/2 \rfloor - 1$, \mathcal{S}_w (resp. $\mathcal{S}_{w'}$) does not involve any vertex in $\mathbf{I} \cap G_C^x$ where $x \in N_C[w']$ (resp. $x \in N_C[w]$). Note that by Proposition 3, \mathcal{S}_w and $\mathcal{S}_{w'}$ can indeed be performed in G . Clearly, after applying both \mathcal{S}_w and $\mathcal{S}_{w'}$, the number of tokens in $N_G(v)$ is reduced. Next, if either w or w' is in \mathbf{I}' , we can simply perform either \mathcal{S}_w or $\mathcal{S}_{w'}$, respectively. If none of them is in \mathbf{I}' , nothing needs to be done.

We have shown that in any case, the number of tokens in $N_G(v)$ is reduced each time we slide the $(G', \mathbf{I} \cap G')$ -movable token in $w \in (N_G(v) \setminus \{u\}) \cap \mathbf{I}$ to a vertex not in $N_G(v)$, and all such slidings can be performed independently (in each component of G'). Eventually, $N_G(v) \cap \mathbf{I} = \{u\}$, and hence we can slide t to v immediately, which implies that t is (G, \mathbf{I}) -movable. \blacktriangleleft

We note that if an induced path P of a cactus G is of even length k , then by Lemma 1, it follows that P is (G, \mathbf{I}) -confined if and only if $\mathbf{I} \cap P$ is a maximum independent set of P and any token placed at $x \in \mathbf{I} \cap P$ is $(G_P^x, \mathbf{I} \cap G_P^x)$ -rigid. Since k is even and $\mathbf{I} \cap P$ is a maximum independent set of P , no token can be slid along any edge of P , i.e., the second condition is equivalent to saying that any token placed at $x \in \mathbf{I} \cap P$ is (G, \mathbf{I}) -rigid. Now, we consider the case k is odd.

► **Lemma 6** (*). *Let G be a cactus. Let $P = p_1 p_2 \dots p_l$ be an induced path in G . Let \mathbf{I} be an independent set of G satisfying that $\mathbf{I} \cap P$ is a maximum independent set of P . Assume that for any $x \in \mathbf{I} \cap P$, the token placed at x is (G, \mathbf{I}) -movable.*

Then, P is (G, \mathbf{I}) -confined if and only if l is even (i.e., the length $k = l - 1$ of P is odd) and there exist two independent sets \mathbf{I}'_1 and \mathbf{I}'_2 such that

- (i) $\mathbf{I} \overset{G}{\rightsquigarrow} \mathbf{I}'$, where $\mathbf{I}' \in \{\mathbf{I}, \mathbf{I}'_1, \mathbf{I}'_2\}$,
- (ii) $\mathbf{I}'_1 \cap P = \{p_1, p_3, \dots, p_{l-1}\}$, $\mathbf{I}'_2 \cap P = \{p_2, p_4, \dots, p_l\}$, and
- (iii) for every $x \in \mathbf{I}' \cap P$, the token placed at x is $(G_P^x, \mathbf{I}' \cap G_P^x)$ -rigid.

The next lemma says that one can decide if the token t placed on u is (G, \mathbf{I}) -rigid in linear time. Consequently, $\mathcal{R}(G, \mathbf{I})$ can be computed in polynomial time.

► **Lemma 7.** *Let \mathbf{I} be an independent set of a cactus G . Let $u \in \mathbf{I}$. One can check if the token t placed on u is (G, \mathbf{I}) -rigid in $O(n)$ time, where $n = |V(G)|$. Consequently, one can determine all (G, \mathbf{I}) -rigid tokens in $O(n^2)$ time.*

Proof. We describe a recursive function $\text{CHECKRIGID}(G, \mathbf{I} \cap G, u)$ for checking if t is (G, \mathbf{I}) -rigid¹. Clearly, if $N_G(u) = \emptyset$ then (by definition) t is (G, \mathbf{I}) -rigid. We then consider the case when $N_G(u) \neq \emptyset$. We want to analyze the cases when t is not (G, \mathbf{I}) -rigid using Lemma 5. If there exists $v \in N_G(u)$ such that $(N_G(v) \setminus \{u\}) \cap \mathbf{I} = \emptyset$ then clearly t is not (G, \mathbf{I}) -rigid. Otherwise, for each $w \in (N_G(v) \setminus \{u\}) \cap \mathbf{I}$, we need to check if the token t_w at w is $(G', \mathbf{I} \cap G')$ -rigid, where $G' = G - N_G[u]$. It suffices to check if t_w is $(H(G', w), \mathbf{I} \cap H(G', w))$ -rigid, where

¹ A pseudo-code of this algorithm is described in Algorithm 1 in the appendix.

$H(G', w)$ is the (connected) component of G' containing w . Note that by the definition of a cactus, it must happen that $1 \leq |N_G(v) \cap H(G', w)| \leq 2$.

Case 1: $N_G(v) \cap H(G', w) = \{w\}$. In this case, the cycle C mentioned in Lemma 5(ii) does not exist. Hence, if for all $w \in (N_G(v) \setminus \{u\}) \cap \mathbf{I}$, t_w is not $(H(G', w), \mathbf{I} \cap H(G', w))$ -rigid, we can immediately conclude that t is not (G, \mathbf{I}) -rigid, because we can slide all t_w to a vertex in $N_{H(G', w)}(w)$ and slide t to v .

Case 2: $N_G(v) \cap H(G', w) = \{w, w'\}$, ($w' \neq w$). In this case, the cycle C mentioned in Lemma 5(ii) does exist. If for all $w \in (N_G(v) \setminus \{u\}) \cap \mathbf{I}$, t_w is not $(H(G', w), \mathbf{I} \cap H(G', w))$ -rigid, we need to check if Lemma 5(ii) holds. If for all component $H(G', w)$ satisfying $N_G(v) \cap H(G', w) = \{w, w'\}$, Lemma 5(ii) does not hold, then we can conclude that t is not (G, \mathbf{I}) -rigid, because we can slide all t_w to a vertex in $N_{H(G', w)}(w)$ (no token is slid to w' during this process) and slide t to v .

We now describe the function CHECKCONFINEDPATH for checking if Lemma 5(ii) holds. Let C be the (unique) cycle in G (of length k) containing v, w (and also w'). Let $P = C - v = p_1 p_2 \dots p_{k-1}$ with $p_1 = w, p_{k-1} = w'$. By the definition of G' , it follows that $u \notin V(C) \subseteq V(G') \cup \{v\}$. Note that for each $x \in V(C) \setminus \{v\} = V(P)$, the graph G_C^x is a subgraph of $H(G', w)$. If $|\mathbf{I} \cap P| < \lfloor k/2 \rfloor$, Lemma 5(ii) clearly does not hold. If k is even then it also does not hold, since t_w is not $(H(G', w), \mathbf{I} \cap H(G', w))$ -rigid. If $|\mathbf{I} \cap P| = \lfloor k/2 \rfloor$, we consider the set of tokens in $\mathbf{I} \cap P$. If there exists a vertex $x \in \mathbf{I} \cap P$ such that the token t_x placed at x is $(G_C^x, \mathbf{I} \cap G_C^x)$ -movable, we can conclude that Lemma 5(ii) does not hold since by moving t_x to a vertex in G_C^x , we also obtain an independent set \mathbf{I}' satisfying $\mathbf{I} \cap G' \overset{G'}{\rightsquigarrow} \mathbf{I}'$ and $|\mathbf{I}' \cap P| < \lfloor k/2 \rfloor$ (see Lemma 1). Thus, we can now consider the case when all t_x ($x \in \mathbf{I} \cap P$) are $(G_C^x, \mathbf{I} \cap G_C^x)$ -rigid. Note that from Lemma 5 and the assumption that t_w (and $t_{w'}$ if $w' \in \mathbf{I}$) is $(H(G', w), \mathbf{I} \cap H(G', w))$ -movable, it follows that for each $x \in \mathbf{I} \cap P$, t_x must be $(H(G', w), \mathbf{I} \cap H(G', w))$ -movable, and thus $(G', \mathbf{I} \cap G')$ -movable (see Proposition 2). Thus, one can now apply Lemma 6. One can construct the independent sets $\mathbf{I}'_1, \mathbf{I}'_2$ described in Lemma 6 from $\mathbf{I} \cap G'$ by sliding tokens in G' (which can also be extended to a TS-sequence in G) as follows. Let i be the smallest index such that $p_i \in \mathbf{I}'_1 \setminus \mathbf{I}$. From the definition of $\mathbf{I}'_1 \cap P$, i must be even. Since $\mathbf{I} \cap P$ is a maximum independent set of P , it follows that $p_j \in \mathbf{I}'_1$ for j odd, $j < i - 1$, and $p_j \in \mathbf{I} \setminus \mathbf{I}'_1$ for j even, $j \geq i$. By Lemma 1, any token placed at $x \in \mathbf{I} \cap P$ must be $(G_P^x, \mathbf{I} \cap G_P^x)$ -rigid. Since the token t_{p_i} on p_i is $(G', \mathbf{I} \cap G')$ -movable but $(G_P^{p_i}, \mathbf{I} \cap G_P^{p_i})$ -rigid, it can only be slid to p_{i-1} . In other words, there exists a TS-sequence \mathcal{S}_{p_i} in G' which slides t_{p_i} to p_{i-1} . Note that \mathcal{S}_{p_i} can be constructed recursively as follows. From Lemma 5, if $(N_{G'}(p_{i-1}) \setminus \{p_i\}) \cap \mathbf{I} = \emptyset$, \mathcal{S}_{p_i} contains only a single step of sliding t_{p_i} to p_{i-1} . On the other hand, if $(N_{G'}(p_{i-1}) \setminus \{p_i\}) \cap \mathbf{I} \neq \emptyset$, there must be a TS-sequence \mathcal{S}'_{p_i} in $G'' = G' - N_{G'}[p_i]$ which slides any token in $(N_{G'}(p_{i-1}) \setminus \{p_i\}) \cap \mathbf{I}$ to some vertex not in $N_{G'}(p_{i-1}) \setminus \{p_i\}$ without having to move a new token to $N_{G'}(p_{i-1}) \setminus \{p_i\}$ beforehand. From Proposition 3, \mathcal{S}'_{p_i} can be extended to a TS-sequence in G' . Hence, \mathcal{S}_{p_i} is constructed by simply performing \mathcal{S}'_{p_i} first, then performing a single sliding step which moves t_{p_i} to p_{i-1} . Repeat the described steps, we finally obtain an independent set \mathbf{I}'_1 which satisfies $\mathbf{I} \cap G' \overset{G'}{\rightsquigarrow} \mathbf{I}'_1$ and $\mathbf{I}'_1 \cap P = \{p_1, p_3, \dots\}$. Note that the recursive construction of \mathcal{S}_{p_i} can indeed be derived from the recursive process of checking rigidity which we are describing. A similar procedure can be applied for constructing \mathbf{I}'_2 . Once we constructed \mathbf{I}'_1 and \mathbf{I}'_2 , we need to check for all $y \in P \cap (\mathbf{I}'_i \setminus \mathbf{I})$ ($i = 1, 2$) whether the token t_y placed at y is $(G_C^y, \mathbf{I}'_i \cap G_C^y)$ -rigid. If all of such t_y are $(G_C^y, \mathbf{I}'_i \cap G_C^y)$ -rigid, by Lemma 6, we conclude that Lemma 5(ii) holds.

Next, we analyze the complexity of our algorithm. Note that the time complexity of this recursive algorithm is proportional to the number of callings of the CHECKRIGID function. Observe that for any vertex $u \in V(G)$, the function CHECKRIGID is called for u at most three times: at most one time during the process of checking Lemma 5(i) (the results of this checking can be used for constructing the sets \mathbf{I}'_1 and \mathbf{I}'_2 described in Lemma 6), and at most two times during the process of checking if Lemma 5(ii) holds. Hence, it takes at most $O(n)$ time to check if a token is (G, \mathbf{I}) -rigid. Therefore, $\mathcal{R}(G, \mathbf{I})$ can be computed in $O(n^2)$ time. \blacktriangleleft

In the remaining part of this section, we consider the second forbidden structure – (G, \mathbf{I}) -confined cycles. Analogously to the case of confined paths, one can also derive (using Lemma 1) that if a cycle C is of even length k , then it is (G, \mathbf{I}) -confined if and only if $\mathbf{I} \cap C$ is a maximum independent set of C and any token placed at $x \in \mathbf{I} \cap C$ is (G, \mathbf{I}) -rigid. Similar to Lemma 6, we have

► **Lemma 8** (*). *Let G be a cactus. Let $C = c_1c_2 \dots c_kc_1$ be a cycle in G . Let \mathbf{I} be an independent set of G satisfying that $\mathbf{I} \cap C$ is a maximum independent set of C . Assume that for any $x \in \mathbf{I} \cap C$, the token placed at x is (G, \mathbf{I}) -movable.*

Then, C is (G, \mathbf{I}) -confined if and only if k is odd and there exist three independent sets $\mathbf{I}'_1, \mathbf{I}'_2$ and \mathbf{I}'_3 such that

- (i) $\mathbf{I} \overset{G}{\rightsquigarrow} \mathbf{I}'$, where $\mathbf{I}' \in \{\mathbf{I}, \mathbf{I}'_1, \mathbf{I}'_2, \mathbf{I}'_3\}$,
- (ii) $\mathbf{I}'_1 \cap C = \{c_1, c_3, \dots, c_{k-2}\}$, $\mathbf{I}'_2 \cap C = \{c_2, c_4, \dots, c_{k-1}\}$, $\mathbf{I}'_3 \cap C = \{c_3, c_5, \dots, c_k\}$, and
- (iii) for every $x \in \mathbf{I}' \cap C$, the token placed at x is $(G_C^x, \mathbf{I}' \cap G_C^x)$ -rigid.

Using Lemma 8, we have

► **Lemma 9** (*). *Let G be a cactus. Let \mathbf{I} be an independent set of G . Assume that $\mathcal{R}(G, \mathbf{I}) = \emptyset$. Then for any cycle C in G , one can decide if C is (G, \mathbf{I}) -confined in $O(n)$ time, where $n = |V(G)|$. Consequently, computing $\mathcal{C}(G, \mathbf{I})$ takes at most $O(n^2)$ time.*

Proof sketch. By modifying the function CHECKCONFINEDPATH in the proof of Lemma 7, one can obtain an algorithm for checking if a length- k -cycle $C = c_1c_2 \dots c_kc_1$ in G is (G, \mathbf{I}) -confined. Keep in mind that C must satisfy the conditions given in Lemma 8. Moreover, since $\mathcal{R}(G, \mathbf{I}) = \emptyset$, it suffices to consider only cycles of odd length. The condition $\mathcal{R}(G, \mathbf{I}) = \emptyset$ also implies that for any $x \in \mathbf{I} \cap C$, the token placed at x is (G, \mathbf{I}) -movable. \blacktriangleleft

5 Sliding tokens on a cactus

In this section, we describe a polynomial-time algorithm for solving SLIDING TOKEN for cacti and prove its correctness. More precisely, we claim that:

► **Theorem 10.** *Let $(G, \mathbf{I}, \mathbf{J})$ be an instance of SLIDING TOKEN where G is a cactus and \mathbf{I}, \mathbf{J} are two independent sets of G . Then, it takes at most $O(n^2)$ time to decide if $\mathbf{I} \overset{G}{\rightsquigarrow} \mathbf{J}$, where $n = |V(G)|$.*

Let $(G, \mathbf{I}, \mathbf{J})$ be an instance of SLIDING TOKEN where G is a cactus and \mathbf{I}, \mathbf{J} are two independent sets of G . The following algorithm decides if $\mathbf{I} \overset{G}{\rightsquigarrow} \mathbf{J}$.

Step 1:

Step 1-1: If $\mathcal{R}(G, \mathbf{I}) \neq \mathcal{R}(G, \mathbf{J})$, return NO.

Step 1-2: Otherwise, remove all vertices in $N_G[\mathcal{R}(G, \mathbf{I})]$ and go to **Step 2**. Let G' be the resulting graph.

Step 2:

Step 2-1: If $\mathcal{C}(G', \mathbf{I} \cap G') \neq \mathcal{C}(G', \mathbf{J} \cap G')$, return NO

Step 2-2: Otherwise, remove all cycles in $\mathcal{C}(G', \mathbf{I} \cap G')$ and go to **Step 3**. Let G'' be the resulting graph.

Step 3: If $|\mathbf{I} \cap F| \neq |\mathbf{J} \cap F|$ for some component F of G'' then return NO. Otherwise, return YES.

We now estimate the running time of this algorithm. First of all, Lemma 7 ensures that **Step 1-1** can be performed in $O(n^2)$ time. **Step 1-2** clearly can be performed in $O(n)$ time. Thus, **Step 1** takes at most $O(n^2)$ time. **Step 2** also takes at most $O(n^2)$ time since by Lemma 9, **Step 2-1** takes $O(n^2)$ time, and **Step 2-2** can be performed in $O(n)$ time. Finally, **Step 3** clearly runs in $O(n)$ time. In total, the algorithm runs in $O(n^2)$ time.

It remains to show the correctness of our algorithm. First of all, we prove an useful observation.

► **Lemma 11** (*). *Let \mathbf{I} be an independent set of a cactus G . Let $v \notin \mathbf{I}$. Assume that $\mathcal{R}(G, \mathbf{I}) = \emptyset$, and $N_G(v) \cap \mathbf{I} \neq \emptyset$. Then, there is at most one $(G', \mathbf{I} \cap G')$ -rigid token in $N_G(v) \cap \mathbf{I}$, where $G' = G - v$. On the other hand, if there exists a cycle C containing v such that the path $P = C - v$ is $(G', \mathbf{I} \cap G')$ -confined, then all tokens in $N_G(v) \cap \mathbf{I}$ must be $(G', \mathbf{I} \cap G')$ -movable. Moreover, if $\mathcal{C}(G, \mathbf{I}) = \emptyset$ then there is at most one cycle C with the above described property.*

The next lemma claims that **Step 1-1** and **Step 2-1** are correct.

► **Lemma 12** (*). *Let \mathbf{I} and \mathbf{J} be independent sets of a cactus G . If $\mathcal{R}(G, \mathbf{I}) \neq \mathcal{R}(G, \mathbf{J})$, then there is no TS-sequence in G which reconfigures \mathbf{I} to \mathbf{J} .*

Assume that $\mathcal{R}(G, \mathbf{I}) = \mathcal{R}(G, \mathbf{J}) = \emptyset$. If $\mathcal{C}(G, \mathbf{I}) \neq \mathcal{C}(G, \mathbf{J})$ then there is no TS-sequence in G which reconfigures \mathbf{I} to \mathbf{J} .

The next lemma ensures the correctness of **Step 1-2** and **Step 2-2**.

► **Lemma 13** (*). *Suppose that $\mathcal{R}(G, \mathbf{I}) = \mathcal{R}(G, \mathbf{J})$ for two given independent sets \mathbf{I} and \mathbf{J} of a cactus G , and let G' be the graph obtained from G by deleting the vertices in $N_G[\mathcal{R}(G, \mathbf{I})] = N_G[\mathcal{R}(G, \mathbf{J})]$. Then $\mathbf{I} \overset{G}{\rightsquigarrow} \mathbf{J}$ if and only if $\mathbf{I} \cap G' \overset{G'}{\rightsquigarrow} \mathbf{J} \cap G'$. Furthermore, $\mathcal{R}(G', \mathbf{I} \cap G') = \mathcal{R}(G', \mathbf{J} \cap G') = \emptyset$.*

Suppose that $\mathcal{C}(G', \mathbf{I} \cap G') = \mathcal{C}(G', \mathbf{J} \cap G') \neq \emptyset$. Let G'' be the graph obtained by removing all cycles in $\mathcal{C}(G', \mathbf{I} \cap G')$. Then $\mathbf{I} \cap G' \overset{G'}{\rightsquigarrow} \mathbf{J} \cap G'$ if and only if $\mathbf{I} \cap G'' \overset{G''}{\rightsquigarrow} \mathbf{J} \cap G''$. Furthermore, $\mathcal{R}(G'', \mathbf{I} \cap G'') = \mathcal{R}(G'', \mathbf{J} \cap G'') = \emptyset$ and $\mathcal{C}(G'', \mathbf{I} \cap G'') = \mathcal{C}(G'', \mathbf{J} \cap G'') = \emptyset$.

Before proving the correctness of **Step 3**, we need some extra definitions. Let B_1, B_2 be two blocks of a cactus G . We say that B_1 is a *neighbor* of B_2 if $V(B_1) \cap V(B_2) \neq \emptyset$. A block B is *safe* if it has at most one cut vertex and at most one neighbor containing more than one cut vertex. For example, the blocks marked with black color in Figure 5 are safe. A vertex $v \in V(G)$ is *safe* if it is a non-cut vertex of some safe block B of G .

For each cut vertex w of G , let \mathcal{B}_w be the smallest subgraph of G such that \mathcal{B}_w contains all safe blocks of G containing w (see Figure 5). \mathcal{B}_w can also be viewed as a collection of safe blocks sharing the same cut vertex w . Observe that for two distinct cut vertices w_1, w_2 , $V(\mathcal{B}_{w_1}) \cap V(\mathcal{B}_{w_2}) = \emptyset$. If no safe block contains w , we define $\mathcal{B}_w = \emptyset$.

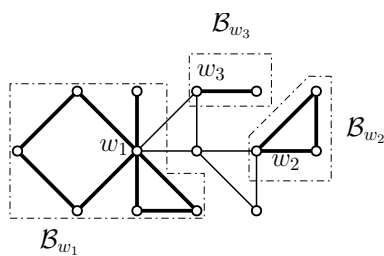

■ **Figure 5** Examples of safe blocks.

Let w be a cut vertex of a cactus G such that $\mathcal{B}_w \neq \emptyset$. For each block $B \in \mathcal{B}_w$, since each block of G is either K_2 or a simple cycle and all blocks in \mathcal{B}_w share the same (unique) cut vertex w , without loss of generality, assume that the vertices of B are labeled as $v_0[B], v_1[B], \dots, v_{|B|-1}[B]$ such that $v_0[B] = w$; $v_i[B]$ is adjacent to $v_{i+1}[B]$, $i \in \{1, 2, \dots, |B| - 2\}$; and $v_0[B]$ is adjacent to $v_{|B|-1}[B]$.

► **Lemma 14** (*). *Let \mathbf{I} be an independent set of a given cactus G . Assume that $\mathcal{R}(G, \mathbf{I}) = \emptyset$ and $\mathcal{C}(G, \mathbf{I}) = \emptyset$. Let w be a cut vertex of G such that $\mathcal{B}_w \neq \emptyset$. Assume that $|\mathbf{I}| \geq \sum_{B \in \mathcal{B}_w} (\lfloor |B|/2 \rfloor - 1)$.*

- (i) *If $\sum_{B \in \mathcal{B}_w} (\lfloor |B|/2 \rfloor - 1) = 0$, then there exists an independent set \mathbf{I}' satisfying that $\mathbf{I} \overset{G}{\rightsquigarrow} \mathbf{I}'$ and $v \in \mathbf{I}'$, where $v \in V(\mathcal{B}_w)$ is some safe vertex of G and $|B|$ denotes the number of vertices of $B \in \mathcal{B}_w$.*
- (ii) *If $\sum_{B \in \mathcal{B}_w} (\lfloor |B|/2 \rfloor - 1) \geq 1$, then there exists an independent set \mathbf{I}' satisfying that $\mathbf{I} \overset{G}{\rightsquigarrow} \mathbf{I}'$, $N_{\mathcal{B}_w}(w) \cap \mathbf{I}' = \emptyset$, and $|\mathbf{I}' \cap (\mathcal{B}_w - w)| = \sum_{B \in \mathcal{B}_w} (\lfloor |B|/2 \rfloor - 1)$.*

► **Lemma 15** (*). *Let \mathbf{I} be an independent set of a given cactus G . Assume that $\mathcal{R}(G, \mathbf{I}) = \emptyset$, and $\mathcal{C}(G, \mathbf{I}) = \emptyset$. Let w be a cut vertex of G such that $\mathcal{B}_w \neq \emptyset$.*

- (i) *If $\sum_{B \in \mathcal{B}_w} (\lfloor |B|/2 \rfloor - 1) = 0$. Let $v \in V(\mathcal{B}_w)$ be a safe vertex of G . Assume that $v \in \mathbf{I}$. Then, $\mathcal{R}(G^*, \mathbf{I}^*) = \emptyset$, where G^* is the graph obtained from G by removing all vertices in \mathcal{B}_w and $\mathbf{I}^* = \mathbf{I} \cap G^*$. Moreover, $\mathcal{C}(G^*, \mathbf{I}^*) = \emptyset$.*
- (ii) *If $\sum_{B \in \mathcal{B}_w} (\lfloor |B|/2 \rfloor - 1) \geq 1$. Assume that $\mathbf{I} \cap (\mathcal{B}_w - w) = \mathbf{I} \cap \bigcup_{B \in \mathcal{B}_w} \{v_2[B], v_4[B], \dots\}$, $|\mathbf{I} \cap (\mathcal{B}_w - w)| = \sum_{B \in \mathcal{B}_w} (\lfloor |B|/2 \rfloor - 1)$ and $N_{\mathcal{B}_w}(w) \cap \mathbf{I} = \emptyset$. Let G^* be the graph obtained from G by removing all vertices in $N_G[\mathbf{I} \cap (\mathcal{B}_w - w)]$ and $\mathbf{I}^* = \mathbf{I} \cap G^*$. Then $\mathcal{R}(G^*, \mathbf{I}^*) = \emptyset$ and $\mathcal{C}(G^*, \mathbf{I}^*) = \emptyset$.*

The next lemma ensures the correctness of **Step 3**.

► **Lemma 16** (*). *Let G be a cactus. Let \mathbf{I} and \mathbf{J} be two given independent sets of G . Assume that $\mathcal{R}(G, \mathbf{I}) = \mathcal{R}(G, \mathbf{J}) = \emptyset$ and $\mathcal{C}(G, \mathbf{I}) = \mathcal{C}(G, \mathbf{J}) = \emptyset$. Then $\mathbf{I} \overset{G}{\rightsquigarrow} \mathbf{J}$ if and only if $|\mathbf{I}| = |\mathbf{J}|$.*

Acknowledgements. We would like to thank Yota Otachi, Takehiro Ito, Tatsuhiko Hatanaka, Haruka Mizuta and Yuhei Moriya for their useful comments and discussions.

References

- 1 Marthe Bonamy and Nicolas Bousquet. Token sliding on chordal graphs. *arXiv preprint*, 2016. [arXiv:1605.00442](https://arxiv.org/abs/1605.00442).
- 2 Paul Bonsma, Marcin Kamiński, and Marcin Wrochna. Reconfiguring independent sets in claw-free graphs. In R. Ravi and IngeLi Gørtz, editors, *Algorithm Theory – SWAT 2014*, volume 8503 of *LNCS*, pages 86–97. Springer, 2014.

- 3 Luis Cereceda, Jan van den Heuvel, and Matthew Johnson. Finding paths between 3-colorings. *Journal of Graph Theory*, 67(1):69–82, 2011.
- 4 Erik D. Demaine, Martin L. Demaine, Eli Fox-Epstein, Duc A. Hoang, Takehiro Ito, Hiro-taka Ono, Yota Otachi, Ryuhei Uehara, and Takeshi Yamada. Linear-time algorithm for sliding tokens on trees. *Theoretical Computer Science*, 600:132–142, 2015.
- 5 Reinhard Diestel. *Graph Theory*, volume 173 of *Graduate Texts in Mathematics*. Springer, 4th edition, 2010.
- 6 Eli Fox-Epstein, Duc A. Hoang, Yota Otachi, and Ryuhei Uehara. Sliding token on bipartite permutation graphs. In Khaled Elbassioni and Kazuhisa Makino, editors, *Algorithms and Computation – ISAAC 2015*, volume 9472 of *LNCS*, pages 237–247. Springer, 2015.
- 7 Martin Gardner. The hypnotic fascination of sliding-block puzzles. *Scientific American*, 210(2):122, 1964.
- 8 Parikshit Gopalan, Phokion G. Kolaitis, Elitza Maneva, and Christos H. Papadimitriou. The connectivity of Boolean satisfiability: computational and structural dichotomies. *SIAM Journal on Computing*, 38(6):2330–2355, 2009.
- 9 Robert A. Hearn and Erik D. Demaine. PSPACE-completeness of sliding-block puzzles and other problems through the nondeterministic constraint logic model of computation. *Theoretical Computer Science*, 343(1):72–96, 2005.
- 10 Takehiro Ito, Erik D. Demaine, Nicholas J. A. Harvey, Christos H. Papadimitriou, Martha Sideri, Ryuhei Uehara, and Yushi Uno. On the complexity of reconfiguration problems. *Theoretical Computer Science*, 412(12):1054–1065, 2011.
- 11 Marcin Kamiński, Paul Medvedev, and Martin Milanič. Complexity of independent set reconfigurability problems. *Theoretical Computer Science*, 439:9–15, 2012.
- 12 Kazuhisa Makino, Suguru Tamaki, and Masaki Yamamoto. An exact algorithm for the Boolean connectivity problem for k -CNF. *Theoretical Computer Science*, 412(35):4613–4618, 2011.
- 13 Amer E. Mouawad, Naomi Nishimura, Vinayak Pathak, and Venkatesh Raman. Shortest reconfiguration paths in the solution space of Boolean formulas. In M. Magnús Halldórsson, Kazuo Iwama, Naoki Kobayashi, and Bettina Speckmann, editors, *Automata, Languages, and Programming – ICALP 2015*, volume 9134 of *LNCS*. Springer, 2015.
- 14 Amer E. Mouawad, Naomi Nishimura, Venkatesh Raman, Narges Simjour, and Akira Suzuki. On the parameterized complexity of reconfiguration problems. In Gregory Gutin and Stefan Szeider, editors, *Parameterized and Exact Computation – IPEC 2013*, volume 8246 of *LNCS*, pages 281–294. Springer, 2013.
- 15 Amer E. Mouawad, Naomi Nishimura, Venkatesh Raman, and Marcin Wrochna. Reconfiguration over tree decompositions. In Marek Cygan and Pinar Heggernes, editors, *Parameterized and Exact Computation – IPEC 2014*, volume 8894 of *LNCS*, pages 246–257. Springer, 2014.
- 16 Moritz Mühlenthaler. Degree-constrained subgraph reconfiguration is in P. In Giuseppe F. Italiano, Giovanni Pighizzini, and Donald T. Sannella, editors, *Mathematical Foundations of Computer Science – MFCS 2015*, volume 9235 of *LNCS*, pages 505–516. Springer, 2015.
- 17 Jan van den Heuvel. The complexity of change. In Simon R. Blackburn, Stefanie Gerke, and Mark Wildon, editors, *Surveys in Combinatorics 2013*, pages 127–160. Cambridge University Press, 2013.
- 18 Takeshi Yamada and Ryuhei Uehara. Shortest reconfiguration of sliding tokens on a caterpillar. In Mohammad Kaykobad and Rossella Petreschi, editors, *Algorithms and Computation – WALCOM 2016*, volume 9627 of *LNCS*, pages 236–248. Springer, 2016.

A

 Details of Section 3

Proof of Lemma 1. We claim that (i) \Leftrightarrow (ii) and (ii) \Leftrightarrow (iii).

- (i) \Leftrightarrow (ii).
 - (i) \Rightarrow (ii). Assume that (i) holds, i.e., $\mathbf{I} \cap H$ is maximum and all tokens placed at vertices in $\mathbf{I} \cap H$ are $(G, \mathbf{I}, V(H))$ -confined. Clearly, this implies (ii).
 - (ii) \Rightarrow (i). Assume that (ii) holds. i.e., for every independent set \mathbf{J} satisfying $\mathbf{I} \overset{G}{\rightsquigarrow} \mathbf{J}$, $\mathbf{J} \cap H$ is a maximum independent set of H . It follows that no token can be slid from a vertex in H to a vertex in $G - H$. Moreover, since $\mathbf{J} \cap H$ is always maximum, no token can be slid from a vertex in $G - H$ to H . Thus, any token placed at a vertex in $\mathbf{I} \cap H$ can only be slid along edges of H , i.e., it is $(G, \mathbf{I}, V(H))$ -confined.
- (ii) \Leftrightarrow (iii).
 - (ii) \Rightarrow (iii). Assume that (ii) holds. First of all, it is clear that $\mathbf{I} \cap H$ is maximum. Assume that there exists an independent set \mathbf{J} , $\mathbf{I} \overset{G}{\rightsquigarrow} \mathbf{J}$, and a vertex $x \in \mathbf{J} \cap H$ such that the token t_x placed at x is $(G_H^x, \mathbf{J} \cap G_H^x)$ -movable, i.e., (iii) does not hold. Let $\mathcal{S} = \langle \mathbf{I}_1 = \mathbf{I}, \mathbf{I}_2, \dots, \mathbf{I}_\ell = \mathbf{J} \rangle$ be a TS-sequence in G which reconfigures \mathbf{I} to \mathbf{J} . Let $\mathcal{S}' = \langle \mathbf{I}'_1 = \mathbf{J} \cap G_H^x, \mathbf{I}'_2, \dots, \mathbf{I}'_k \rangle$ be a TS-sequence in G_H^x which slides x to a vertex $y \in N_{G_H^x}(x)$. By definition of G_H^x , $y \notin V(H)$. Without loss of generality, assume that $x \in \mathbf{I}'_j \setminus \mathbf{I}'_k$ and $y \in \mathbf{I}'_k \setminus \mathbf{I}'_j$, where $j = 1, 2, \dots, k-1$. For any independent set \mathbf{I} of G , $\mathbf{I} \cap G_H^x$ is also an independent set of G_H^x . Therefore, one can construct the TS-sequence $\langle \mathbf{I}_1 \cap G_H^x, \mathbf{I}_2 \cap G_H^x, \dots, \mathbf{I}_\ell \cap G_H^x \rangle$ from \mathcal{S} . Thus, we have $\mathbf{I} \cap G_H^x \overset{G_H^x}{\rightsquigarrow} \mathbf{J} \cap G_H^x \overset{G_H^x}{\rightsquigarrow} \mathbf{I}'_{k-1}$. Note that for any independent set \mathbf{I}' of G_H^x , since $V(G_H^x) \cap (\mathbf{I} - G_H^x) = \emptyset$ the set $\mathbf{I}' \cup (\mathbf{I} - G_H^x)$ is also independent. Therefore, $\mathbf{I} \overset{G}{\rightsquigarrow} \mathbf{J} \overset{G}{\rightsquigarrow} \mathbf{I}'_{k-1} \cup (\mathbf{I} - G_H^x)$. Let $\mathbf{J}' = \mathbf{I}'_{k-1} \cup (\mathbf{I} - G_H^x)$ then by our assumption $\mathbf{J}' \cap H$ is a maximum independent set of H . Let $\mathbf{J}'' = \mathbf{I}'_k \cup (\mathbf{I} - G_H^x)$. Similarly, we also have $\mathbf{J}'' \cap H$ must be a maximum independent set of H . Since $\mathbf{J}' \setminus \mathbf{J}'' = \{y\}$, $\mathbf{J}'' \setminus \mathbf{J}' = \{x\}$, and $y \notin V(H)$, this is a contradiction.
 - (iii) \Rightarrow (ii). Assume that (iii) holds. Assume that there exists an independent set \mathbf{J} such that $\mathbf{I} \overset{G}{\rightsquigarrow} \mathbf{J}$ but $\mathbf{J} \cap H$ is not a maximum independent set of H , i.e., (ii) does not hold. Let $\mathcal{S} = \langle \mathbf{I}_1 = \mathbf{I}, \mathbf{I}_2, \dots, \mathbf{I}_\ell = \mathbf{J} \rangle$ be a TS-sequence which reconfigures \mathbf{I} to \mathbf{J} . Without loss of generality, assume that $\mathbf{I}_i \cap H$ is a maximum independent set of H for $i = 1, 2, \dots, \ell-1$. Let $x \in \mathbf{I}_{\ell-1} \setminus \mathbf{I}_\ell$ and $y \in \mathbf{I}_\ell \setminus \mathbf{I}_{\ell-1}$. Since $\mathbf{I}_\ell \cap H$ is not a maximum independent set of H , $|\mathbf{I}_\ell \cap H| < |\mathbf{I}_i \cap H|$ for $i = 1, 2, \dots, \ell-1$. Hence, $y \notin V(H)$. Since $N_G(x) = N_{G_H^x}(x) \cup N_H(x)$ and $N_{G_H^x}(x) \cap N_H(x) = \emptyset$, y must be in G_H^x , which implies that \mathcal{S} slides a token t_x on x to a vertex $y \in V(G_H^x)$. As in the previous part, one can indeed derive a TS-sequence in G_H^x from \mathcal{S} which slides t_x to y , i.e., it is $(G_H^x, \mathbf{I}_{\ell-1} \cap G_H^x)$ -movable. This is a contradiction. \blacktriangleleft

Proof of Proposition 2. Assume that $\mathcal{S} = \langle \mathbf{I}_1, \dots, \mathbf{I}_\ell \rangle$ is a TS-sequence in G that reconfigures $\mathbf{I} = \mathbf{I}_1$ to $\mathbf{J} = \mathbf{I}_\ell$. For any $i \in \{1, 2, \dots, k\}$ and any independent set \mathbf{I} of G , as $\mathbf{I} \cap G_i \subseteq \mathbf{I}$, $\mathbf{I} \cap G_i$ is also independent. Hence, $\mathcal{S}_i = \langle \mathbf{I}_1 \cap G_i, \dots, \mathbf{I}_\ell \cap G_i \rangle$ reconfigures $\mathbf{I} \cap G_i$ to $\mathbf{J} \cap G_i$.

Assume that for each $i \in \{1, 2, \dots, k\}$, there exists a TS-sequence \mathcal{S}'_i in G_i that reconfigures $\mathbf{I} \cap G_i$ to $\mathbf{J} \cap G_i$. For any two TS-sequences \mathcal{S}'_i and \mathcal{S}'_j ($i, j \in \{1, 2, \dots, k\}$), if the length of \mathcal{S}'_i is smaller than the length of \mathcal{S}'_j then we can make them equal by appending $\langle \mathbf{I} \cap G_i, \mathbf{I} \cap G_i, \dots \rangle$ to the end of \mathcal{S}'_i . Thus, assume that all \mathcal{S}'_i are of equal length, i.e., any \mathcal{S}'_i can be written in the form $\langle \mathbf{I}_1^i = \mathbf{I} \cap G_i, \dots, \mathbf{I}_\ell^i = \mathbf{J} \cap G_i \rangle$. Let \mathbf{I}^i be an independent set of G_i . Since G_1, G_2, \dots, G_k are components of G , $\bigcup_{i=1}^k \mathbf{I}^i$ forms an independent set of G .

Thus, we can extend any sequence \mathcal{S}'_i ($i = 1, 2, \dots, k$) to a TS-sequence \mathcal{S}_i in G as follows.

$$\mathcal{S}_i = \langle \mathbf{I}_1^i \cup \bigcup_{j=1}^{i-1} \mathbf{I}_1^j \cup \bigcup_{j=i+1}^k \mathbf{I}_1^j, \dots, \mathbf{I}_i^i \cup \bigcup_{j=1}^{i-1} \mathbf{I}_i^j \cup \bigcup_{j=i+1}^k \mathbf{I}_1^j \rangle.$$

Clearly, the sequence \mathcal{S} constructed by first applying \mathcal{S}_1 , then \mathcal{S}_2 , and so on is the one that reconfigures \mathbf{I} to \mathbf{J} in G . \blacktriangleleft

Proof of Proposition 3. Since $u \in \mathbf{I}$ for any $\mathbf{I} \in \mathcal{S}$, the sequence $\mathcal{S}' = \langle \mathbf{I}_1 \setminus \{u\}, \dots, \mathbf{I}_\ell \setminus \{u\} \rangle$ clearly reconfigures $\mathbf{I}_1 \cap G' = \mathbf{I}_1 \setminus \{u\}$ to $\mathbf{I}_\ell \cap G' = \mathbf{I}_\ell \setminus \{u\}$. For any independent set \mathbf{I}' of G' , $\mathbf{I}' \cup \{u\}$ clearly forms an independent set of G . Hence, $\mathcal{S} = \langle \mathbf{I}'_1 \cup \{u\}, \dots, \mathbf{I}'_\ell \cup \{u\} \rangle$ reconfigures $\mathbf{I}'_1 \cup \{u\}$ to $\mathbf{I}'_\ell \cup \{u\}$. \blacktriangleleft

Proof of Lemma 4. If $\mathbf{I} \xrightarrow{C} \mathbf{J}$ then clearly $|\mathbf{I}| = |\mathbf{J}|$. Now, assume that $|\mathbf{I}| = |\mathbf{J}|$. We claim that $\mathbf{I} \xrightarrow{C} \mathbf{J}$. Let $C = v_1 v_2 \dots v_k v_1$. Let \mathbf{I}' be an independent set of C such that $|\mathbf{I}'| = |\mathbf{I}| = |\mathbf{J}| \leq \lfloor k/2 \rfloor$ and $v_i \in \mathbf{I}'$ if i is odd. We claim that $\mathbf{I} \xrightarrow{C} \mathbf{I}'$. Similarly, one can also show that $\mathbf{J} \xrightarrow{C} \mathbf{I}'$. Consider the following cases:

Case 1: $|\mathbf{I}| = \lfloor k/2 \rfloor$. Since there are no (C, \mathbf{I}) -rigid tokens and $|\mathbf{I}| = \lfloor k/2 \rfloor$, k must be odd.

Let i be the smallest index such that $v_i \in \mathbf{I} \setminus \mathbf{I}'$, $2 \leq i \leq k$. Hence, from the definition of \mathbf{I}' , i must be even. Moreover, $v_j \in \mathbf{I}'$ for odd j , $1 \leq j < i - 1$, and $v_j \in \mathbf{I}$ for even j , $i \leq j \leq k - 1$. Hence, one can slide the token on v_i to $v_{i-1} \in \mathbf{I}' \setminus \mathbf{I}$, then slide the token on v_{i+2} to v_{i+1} , and so on. Let \mathcal{S} be the TS-sequence describing the above process, then clearly $\mathbf{I} \xrightarrow{C} \mathbf{I}'$, since each sliding step reduces $|\mathbf{I} \setminus \mathbf{I}'|$.

Case 2: $|\mathbf{I}| < \lfloor k/2 \rfloor$. Let i be the smallest index such that $v_i \in \mathbf{I} \setminus \mathbf{I}'$, $2 \leq i \leq k$. If $i = 2$ then since there are no (C, \mathbf{I}) -rigid tokens, we can assume without loss of generality that $v_k \notin \mathbf{I}$; otherwise there exists a TS-sequence that slides the token in v_k to v_{k-1} and then one can deal with the resulting independent set. Let j be the smallest index such that $v_j \in \mathbf{I}' \setminus \mathbf{I}$, $1 \leq j \leq k$. Since $v_i \notin \mathbf{I}'$, $i > j$. Now, one can slide v_i to v_j and repeat the process. Let \mathcal{S} be the TS-sequence describing the above process, then clearly $\mathbf{I} \xrightarrow{C} \mathbf{I}'$. \blacktriangleleft

B Details of Section 4

Proof of Lemma 6.

(\Leftarrow). Assume that l is even and the described independent sets $\mathbf{I}'_1, \mathbf{I}'_2$ exist. Since $\mathbf{I} \cap P$ is a maximum independent set of P , it suffices to show that all tokens in $\mathbf{I} \cap P$ are $(G, \mathbf{I}, V(P))$ -confined. By Lemma 1, it is equivalent to saying that for every \mathbf{J} satisfying $\mathbf{I} \xrightarrow{G} \mathbf{J}$, any token placed at $x \in P \cap \mathbf{J}$ is $(G_P^x, \mathbf{J} \cap G_P^x)$ -rigid. Let $x \in \mathbf{J} \cap \mathbf{I}'_1 \cap P$ for some \mathbf{J} such that $\mathbf{I} \xrightarrow{G} \mathbf{J}$ and suppose that the token t_x placed at x is $(G_P^x, \mathbf{I}'_1 \cap G_P^x)$ -rigid. We claim that it is also $(G_P^x, \mathbf{J} \cap G_P^x)$ -rigid. Assume for the contradiction that there exists an independent set \mathbf{J}' of G_P^x such that $\mathbf{J} \cap G_P^x \xrightarrow{G_P^x} \mathbf{J}'$ but $x \notin \mathbf{J}'$. For any independent set \mathbf{I} of G , note that $\mathbf{I} \cap G_P^x$ is also independent. Hence, it follows that $\mathbf{I}'_1 \cap G_P^x \xrightarrow{G_P^x} \mathbf{J} \cap G_P^x \xrightarrow{G_P^x} \mathbf{J}'$, which then implies that t_x is not $(G_P^x, \mathbf{I}'_1 \cap G_P^x)$ -rigid. This is a contradiction. Hence, for every independent set \mathbf{J} with $\mathbf{I} \xrightarrow{G} \mathbf{J}$, any token in $\mathbf{J} \cap \mathbf{I}'_1 \cap P$ is $(G_P^x, \mathbf{J} \cap G_P^x)$ -rigid. Similarly, for every independent set \mathbf{J} with $\mathbf{I} \xrightarrow{G} \mathbf{J}$, any token in $\mathbf{J} \cap \mathbf{I}'_2 \cap P$ is also $(G_P^x, \mathbf{J} \cap G_P^x)$ -rigid. Moreover, for every \mathbf{J} with $\mathbf{I} \xrightarrow{G} \mathbf{J}$, $\mathbf{J} \cap P = (\mathbf{J} \cap \mathbf{I}'_1 \cap P) \cup (\mathbf{J} \cap \mathbf{I}'_2 \cap P)$. Hence, every token placed at $x \in \mathbf{J} \cap P$ is $(G_P^x, \mathbf{J} \cap G_P^x)$ -rigid.

(\Rightarrow). Assume that P is (G, \mathbf{I}) -confined. Since $\mathbf{I} \cap P$ is a maximum independent set of P and any token placed at $x \in \mathbf{I} \cap P$ is (G, \mathbf{I}) -movable, it follows that l must be even. We show how to construct \mathbf{I}'_1 from \mathbf{I} using TS rule. A similar process can be applied for \mathbf{I}'_2 . Let i be the smallest index such that $p_i \in \mathbf{I}'_1 \setminus \mathbf{I}$. From the definition of $\mathbf{I}'_1 \cap P$, i must be even. Since $\mathbf{I} \cap P$ is a maximum independent set of P , it follows that $p_j \in \mathbf{I}'_1$ for j odd, $j < i - 1$, and $p_j \in \mathbf{I} \setminus \mathbf{I}'_1$ for j even, $j \geq i$. By Lemma 1, any token placed at $x \in \mathbf{I} \cap P$ must be $(G_P^x, \mathbf{I} \cap G_P^x)$ -rigid. Since the token t_{p_i} on p_i is (G, \mathbf{I}) -movable but $(G_P^{p_i}, \mathbf{I} \cap G_P^{p_i})$ -rigid, it can only be slid to p_{i-1} . In other words, there exists a TS-sequence \mathcal{S}_{p_i} in G which slides t_{p_i} to p_{i-1} . Note that \mathcal{S}_{p_i} can be constructed recursively as follows. From Lemma 5, if $(N_G(p_{i-1}) \setminus \{p_i\}) \cap \mathbf{I} = \emptyset$, \mathcal{S}_{p_i} contains only a single step of sliding t_{p_i} to p_{i-1} . On the other hand, if $(N_G(p_{i-1}) \setminus \{p_i\}) \cap \mathbf{I} \neq \emptyset$, there must be a TS-sequence \mathcal{S}'_{p_i} in $G' = G - N_G[p_i]$ which slides any token in $(N_G(p_{i-1}) \setminus \{p_i\}) \cap \mathbf{I}$ to some vertex not in $N_G(p_{i-1}) \setminus \{p_i\}$ without having to move a new token to $N_G(p_{i-1}) \setminus \{p_i\}$ beforehand. From Proposition 3, \mathcal{S}'_{p_i} can be extended to a TS-sequence in G . Hence, \mathcal{S}_{p_i} is constructed by simply performing \mathcal{S}'_{p_i} first, then performing a single sliding step which moves t_{p_i} to p_{i-1} . Repeat the described steps, we finally obtain an independent set \mathbf{I}'_1 which satisfies $\mathbf{I} \cap G' \xleftrightarrow{G'} \mathbf{I}'_1$ and $\mathbf{I}'_1 \cap P = \{p_1, p_3, \dots\}$. \blacktriangleleft

Proof of Lemma 8.

(\Leftarrow). Assume that k is odd and the described independent sets $\mathbf{I}'_1, \mathbf{I}'_2, \mathbf{I}'_3$ exist. As in Lemma 6, it suffices to show that for every \mathbf{J} with $\mathbf{I} \xleftrightarrow{G} \mathbf{J}$, every token placed at $x \in \mathbf{J} \cap C$ is $(G_C^x, \mathbf{J} \cap G_C^x)$ -rigid. For $i \in \{1, 2, 3\}$, let $x \in \mathbf{J} \cap \mathbf{I}'_i \cap C$ for some \mathbf{J} such that $\mathbf{I} \xleftrightarrow{G} \mathbf{J}$ and suppose that the token t_x placed at x is $(G_C^x, \mathbf{I}'_i \cap G_C^x)$ -rigid. Using a similar argument as in the proof of Lemma 6, one can show that t_x is also $(G_C^x, \mathbf{J} \cap G_C^x)$ -rigid. Moreover, for every \mathbf{J} with $\mathbf{I} \xleftrightarrow{G} \mathbf{J}$, $\mathbf{J} \cap C = \bigcup_{i=1}^3 (\mathbf{J} \cap \mathbf{I}'_i \cap C)$. Hence, every token placed at $x \in \mathbf{J} \cap C$ is $(G_C^x, \mathbf{J} \cap G_C^x)$ -rigid, which completes the first part of our proof.

(\Rightarrow). Assume that C is (G, \mathbf{I}) -confined. Since $\mathbf{I} \cap C$ is a maximum independent set of C and any token placed at $x \in \mathbf{I} \cap C$ is (G, \mathbf{I}) -movable, it follows that k must be odd. The construction of \mathbf{I}'_1 and \mathbf{I}'_2 can be done similar as in the proof of Lemma 6. For constructing \mathbf{I}'_3 , instead of starting from \mathbf{I} , we start from \mathbf{I}'_1 as the only TS-sequence we need is the one that slides the token at c_1 to c_k , which can be obtained from the result of checking if the token placed at c_1 is (G, \mathbf{I}'_1) -rigid. \blacktriangleleft

Proof of Lemma 9. Assume that $\mathcal{R}(G, \mathbf{I}) = \emptyset$. We modified the function CHECKCONFINED-PATH in Algorithm 1 to check if a length- k -cycle $C = c_1 c_2 \dots c_k c_1$ in G is (G, \mathbf{I}) -confined as follows (see function CHECKCONFINEDCYCLE in Algorithm 2). If k is even or $|\mathbf{I} \cap C| < \lfloor k/2 \rfloor$ then clearly C is not (G, \mathbf{I}) -confined. Otherwise, we first check if the token t_x placed at $x \in \mathbf{I} \cap C$ are $(G_C^x, \mathbf{I} \cap G_C^x)$ -rigid or not. If some of them does not satisfy the above condition, then we can conclude that C is not (G, \mathbf{I}) -confined as some token t_x can be slid to a vertex in G_C^x . Otherwise, we call the CHECKRIGID function (in Algorithm 1) for each vertex in $\mathbf{I} \cap C$. Note that $\mathcal{R}(G, \mathbf{I}) = \emptyset$, thus it must return NO and a TS-sequence which then can be used for constructing the described sets $\mathbf{I}'_1, \mathbf{I}'_2$ and \mathbf{I}'_3 in Lemma 8. For constructing \mathbf{I}'_3 , we start from \mathbf{I}'_1 instead of \mathbf{I} and hence need to perform checking if the token placed at c_1 is (G, \mathbf{I}'_1) -rigid or not beforehand. Next, after constructing these three independent sets, we check for all $y \in C \cap (\mathbf{I}'_i \setminus \mathbf{I})$ ($i = 1, 2, 3$) whether the token t_y placed at y is $(G_C^y, \mathbf{I}'_i \cap G_C^y)$ -rigid. If all of such t_y are $(G_C^y, \mathbf{I}'_i \cap G_C^y)$ -rigid, by Lemma 8, we conclude that C is indeed (G, \mathbf{I}) -confined.

As in the case of Algorithm 1, in Algorithm 2, for each vertex $u \in V(G)$, the CHECKRIGID function is called at most 5 times: at most one time during the process of checking if it is

Algorithm 1 Check if a token on $u \in \mathbf{I}$ is (G, \mathbf{I}) -rigid.

Require: A cactus G , an independent set \mathbf{I} of G , and a vertex $u \in \mathbf{I}$.

Ensure: Return YES if the token on u is (G, \mathbf{I}) -rigid; otherwise, return NO and a TS-sequence \mathcal{S}_u which slides t to some vertex $v \in N_G(u)$.

```

1: function CHECKRIGID( $G, \mathbf{I}, u$ ) ▷ Check if a token  $t$  on  $u$  is  $(G, \mathbf{I})$ -rigid.
2:   if  $N_G(u) = \emptyset$  then
3:     return YES
4:   end if
5:   for all  $v \in N_G(u)$  do
6:     if  $(N_G(v) \setminus \{u\}) \cap \mathbf{I} = \emptyset$  then
7:       return NO and a TS-sequence  $\mathcal{S}_u$  involving the single step of sliding  $t$  from  $u$  to  $v$ .
8:     end if
9:     for  $w \in (N_G(v) \setminus \{u\}) \cap \mathbf{I}$  do
10:      Let  $G' = G - N_G[u]$ .
11:      Let  $H(G', w)$  be the component of  $G'$  containing  $w$ .
12:      CHECKRIGID( $H(G', w), \mathbf{I} \cap H(G', w), w$ )
13:      CHECKRIGID( $G', \mathbf{I} \cap G', w$ )  $\leftarrow$  CHECKRIGID( $H(G', w), \mathbf{I} \cap H(G', w), w$ )
14:    end for
15:    if CHECKRIGID( $G', \mathbf{I} \cap G', w$ ) = NO for any  $w \in (N_G(v) \setminus \{u\}) \cap \mathbf{I}$  then
16:      for all components  $H(G', w)$  with  $|N_G(v) \cap H(G', w)| = 2$  do
17:        Let  $C$  be the (unique) cycle in  $G$  containing  $v, w$ .
18:        CHECKCONFINEDPATH( $H(G', w), \mathbf{I} \cap H(G', w), C - v$ )
19:      end for
20:      if CHECKCONFINEDPATH( $H(G', w), \mathbf{I} \cap H(G', w), C - v$ ) = NO for any component
21:       $H(G', w)$  with  $|N_G(v) \cap H(G', w)| = 2$  then
22:        return NO and a TS-sequence  $\mathcal{S}_u$  which slides  $t$  from  $u$  to  $v$ .
23:      end if
24:    end for
25:    return YES
26: end function
27: function CHECKCONFINEDPATH( $G, \mathbf{I}, P$ )
28:   Let  $k$  be the length of  $P$ .
29:   if  $k$  is even or  $|\mathbf{I} \cap P| < \lfloor k/2 \rfloor$  then return NO
30:   else
31:     for all  $x \in \mathbf{I} \cap P$  do
32:       if CHECKRIGID( $G_P^x, \mathbf{I} \cap G_P^x, x$ ) = NO then return NO
33:       end if
34:       CHECKRIGID( $G, \mathbf{I}, x$ ) ▷ Must return NO and a TS-sequence which will be used for the
35:       construction of  $\mathbf{I}'_1$  and  $\mathbf{I}'_2$ .
36:     end for
37:     Construct  $\mathbf{I}'_1$  (as in Lemma 6).
38:     for all  $x \in P \cap (\mathbf{I}'_1 \setminus \mathbf{I})$  do
39:       if CHECKRIGID( $G_P^x, \mathbf{I}'_1 \cap G_P^x, x$ ) = NO then return NO
40:       end if
41:     end for
42:     Construct  $\mathbf{I}'_2$  (as in Lemma 6).
43:     for all  $x \in P \cap (\mathbf{I}'_2 \setminus \mathbf{I})$  do
44:       if CHECKRIGID( $G_P^x, \mathbf{I}'_2 \cap G_P^x, x$ ) = NO then return NO
45:       end if
46:     end for
47:     return YES
48:   end if
49: end function

```

Algorithm 2 Check if a cycle is (G, \mathbf{I}) -confined.

Require: A cactus G , an independent set \mathbf{I} of G with $\mathcal{R}(G, \mathbf{I}) = \emptyset$, and a cycle C of G .

Ensure: Return YES if C is (G, \mathbf{I}) -confined; otherwise, return NO.

```

1: function CHECKCONFINEDCYCLE( $G, \mathbf{I}, C$ )
2:   Let  $k$  be the length of  $C$ .
3:   if  $k$  is even or  $|\mathbf{I} \cap C| < \lfloor k/2 \rfloor$  then return NO
4:   else
5:     for all  $x \in \mathbf{I} \cap C$  do
6:       if CHECKRIGID( $G_C^x, \mathbf{I} \cap G_C^x, x$ ) = NO then return NO
7:       end if
8:       CHECKRIGID( $G, \mathbf{I}, x$ )  $\triangleright$  Must return NO (as  $\mathcal{R}(G, \mathbf{I}) = \emptyset$ ) and a TS-sequence
          which will be used for the construction of  $\mathbf{I}'_1, \mathbf{I}'_2$ , and  $\mathbf{I}'_3$ .
9:     end for
10:    Construct  $\mathbf{I}'_1$  (as in Lemma 8).
11:    for all  $x \in (\mathbf{I}'_1 \setminus \mathbf{I}) \cap C$  do
12:      if CHECKRIGID( $G_C^x, \mathbf{I}'_1 \cap G_C^x, x$ ) = NO then return NO
13:      end if
14:    end for
15:    Construct  $\mathbf{I}'_2$  (as in Lemma 8).
16:    for all  $x \in (\mathbf{I}'_2 \setminus \mathbf{I}) \cap C$  do
17:      if CHECKRIGID( $G_C^x, \mathbf{I}'_2 \cap G_C^x, x$ ) = NO then return NO
18:      end if
19:    end for
20:    CHECKRIGID( $G, \mathbf{I}'_1, c_1$ )
21:    Construct  $\mathbf{I}'_3$  (as in Lemma 8).
22:    for all  $x \in (\mathbf{I}'_3 \setminus \mathbf{I}'_1) \cap C$  do
23:      if CHECKRIGID( $G_C^x, \mathbf{I}'_3 \cap G_C^x, x$ ) = NO then return NO
24:      end if
25:    end for
26:    return YES
27:  end if
28: end function

```

(G, \mathbf{I}) -rigid (and should return NO because of our assumption), at most one time during the process of checking if the token placed at c_1 is (G, \mathbf{I}'_1) -rigid and at most three times during the process of checking the conditions described in Lemma 8. Each function CHECKRIGID takes $O(|G|)$ time for any cactus G (see Lemma 7). Thus, it takes $O(n)$ time to decide if a cycle C is (G, \mathbf{I}) -confined. Consequently, computing $\mathcal{C}(G, \mathbf{I})$ takes at most $O(n^2)$ time. \blacktriangleleft

C Details of Section 5

Proof of Lemma 11. Assume that there are two vertices w and w' in $N_G(v) \cap \mathbf{I}$ such that the tokens t_w and $t_{w'}$ placed at w and w' are both $(G', \mathbf{I} \cap G')$ -rigid, respectively (see Figure 6(a)). From the assumption, t_w and $t_{w'}$ must be (G, \mathbf{I}) -movable. Therefore, t_w (at least) can be slid to v . But, this can happen only when $t_{w'}$ can be slid to a vertex in $N_{G'}(w')$, i.e., $t_{w'}$ is $(G', \mathbf{I} \cap G')$ -movable, which contradicts our assumption. Hence, there is at most one $(G', \mathbf{I} \cap G')$ -rigid token in $N_G(v) \cap \mathbf{I}$.

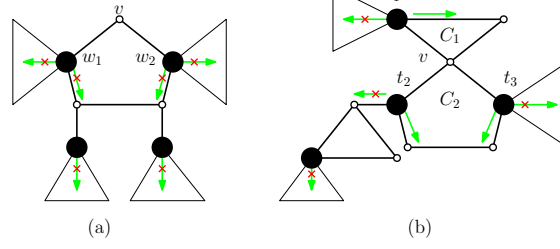

■ **Figure 6** Illustration for Lemma 11

Now, assume that there exists a cycle C containing v such that the path $P = C - v$ is $(G', \mathbf{I} \cap G')$ -confined. By Lemma 1, for every independent set \mathbf{I}' with $\mathbf{I} \cap G' \overset{G'}{\rightsquigarrow} \mathbf{I}'$, $|\mathbf{I} \cap P| = \lfloor k/2 \rfloor$, where k is the length of C . Hence, for every $x \in \mathbf{I} \cap C$, the token on x is at least $(G_C^x, \mathbf{I} \cap G_C^x)$ -rigid. Hence, if k is even, it follows that no token can be slid (in G) along edges of C , i.e., all tokens in $\mathbf{I} \cap C$ are (G, \mathbf{I}) -rigid, which is a contradiction. Therefore, k must be odd. It follows that the tokens in $N_G(v) \cap \mathbf{I} \cap C$ must be $(G', \mathbf{I} \cap G')$ -movable. Now, assume for the contradiction that the token $t_{w'}$ at some vertex $w' \in (N_G(v) \cap \mathbf{I}) - C$ which is $(G', \mathbf{I} \cap G')$ -rigid. Since $t_{w'}$ is (G, \mathbf{I}) -movable, it can at least be slid to v . This is a contradiction to Lemma 5(ii). Hence, every tokens in $N_G(v) \cap \mathbf{I}$ must be $(G', \mathbf{I} \cap G')$ -movable.

Finally, we claim that if $\mathcal{C}(G, \mathbf{I}) = \emptyset$ then there are at most one cycle C containing v such that the path $P = C - v$ is $(G', \mathbf{I} \cap G')$ -confined. Assume for the contradiction that there are two cycles C_1 and C_2 satisfy the above property (see Figure 6(b)). For $i = 1, 2$, since $v \notin \mathbf{I}$ and $\mathbf{I} \cap (C_i - v)$ is a maximum independent set of $C_i - v$, it follows that $\mathbf{I} \cap C_i$ is a maximum independent set of C_i . Additionally, note that $\mathcal{C}(G, \mathbf{I}) = \emptyset$. Thus, there is no $(G, \mathbf{I}, V(C_i))$ -confined token ($i = 1, 2$) placed at any vertex of $\mathbf{I} \cap C_i$. From the assumption, all tokens in $\mathbf{I} \cap (C_i - v) = \mathbf{I} \cap C_i$ are $(G, \mathbf{I}, V(C_i - v))$ -confined. On the other hand, since $\mathbf{I} \cap C_1$ is a maximum independent set of C_1 , there exists a token t_1 at some vertex $v_1 \in N_{C_1}(v)$. As before, t_1 must be $(G, \mathbf{I}, V(C_1 - v))$ -confined and not $(G, \mathbf{I}, V(C_1))$ -confined. Therefore, it can be slid to v . Similarly, there exists a token t_2 at some vertex at some vertex $v_2 \in N_{C_2}(v)$ such that t_2 is $(G, \mathbf{I}, V(C_2 - v))$ -confined and not $(G, \mathbf{I}, V(C_2))$ -confined. Clearly, t_2 must also be slid to v , but this is a contradiction since one need to slide t_1 to a vertex not in $N_G(v)$ first, which can be done (at least) when t_2 has been moved. Note that since $\mathbf{I} \cap C_2$ is a maximum independent set of C_2 , there always exists some token in $N_{C_2}(v)$ while no token in $\mathbf{I} \cap C_2$ is moved to a vertex not in $V(C_2)$. Therefore, there are at most one cycle C containing v such that the path $P = C - v$ is $(G', \mathbf{I} \cap G')$ -confined. ◀

Proof of Lemma 12. By definition, a token t at $u \in \mathbf{I}$ is (G, \mathbf{I}) -rigid if for every \mathbf{J} such that $\mathbf{I} \overset{G}{\rightsquigarrow} \mathbf{J}$, $u \in \mathbf{J}$. It follows that t is also (G, \mathbf{J}) -rigid, since for any independent set \mathbf{J}' such that $\mathbf{J} \overset{G}{\rightsquigarrow} \mathbf{J}'$, $\mathbf{I} \overset{G}{\rightsquigarrow} \mathbf{J} \overset{G}{\rightsquigarrow} \mathbf{J}'$, which then implies $u \in \mathbf{J}'$. Hence, $\mathcal{R}(G, \mathbf{I}) = \mathcal{R}(G, \mathbf{J})$.

Assume that $\mathcal{R}(G, \mathbf{I}) = \mathcal{R}(G, \mathbf{J}) = \emptyset$. We claim that if $\mathbf{I} \overset{G}{\rightsquigarrow} \mathbf{J}$ then $\mathcal{C}(G, \mathbf{I}) = \mathcal{C}(G, \mathbf{J})$. Suppose that there exists a cycle C of G such that $C \in \mathcal{C}(G, \mathbf{I}) \setminus \mathcal{C}(G, \mathbf{J})$. That is, $\mathbf{I} \cap C$ is a maximum independent set of C , and all tokens in $\mathbf{I} \cap C$ are $(G, \mathbf{I}, V(C))$ -confined. By Lemma 1, for every \mathbf{J}' with $\mathbf{I} \overset{G}{\rightsquigarrow} \mathbf{J} \overset{G}{\rightsquigarrow} \mathbf{J}'$, $C \cap \mathbf{J}'$ must also be a maximum independent set of C , and the token t_x placed at $x \in \mathbf{J}' \cap C$ is $(G_C^x, \mathbf{J}' \cap G_C^x)$ -rigid, i.e., $C \in \mathcal{C}(G, \mathbf{J})$, which is a contradiction. ◀

Proof of Lemma 13. Assume that there exists a TS-sequence $\mathcal{S} = \langle \mathbf{I} = \mathbf{I}_1, \mathbf{I}_2, \dots, \mathbf{J} = \mathbf{J} \rangle$ in G which reconfigures \mathbf{I} to \mathbf{J} , and $\mathcal{R}(G, \mathbf{I}) = \mathcal{R}(G, \mathbf{J})$. We show that $\mathbf{I} \cap G' \xrightarrow{G'} \mathbf{J} \cap G'$. Since no tokens can be placed at any neighbor of $\mathcal{R}(G, \mathbf{I}) = \mathcal{R}(G, \mathbf{J}) = \mathcal{R}(G, \mathbf{I}_i)$ ($i = 1, 2, \dots, r$), for any independent set \mathbf{I} of G , $\mathbf{I} \setminus \mathcal{R}(G, \mathbf{I})$ is indeed an independent set of G' . For any $i \in \{2, \dots, r\}$, let $u \in \mathbf{I}_{i-1} \setminus \mathbf{I}_i$ and $v \in \mathbf{I}_i \setminus \mathbf{I}_{i-1}$. Since $u \notin \mathbf{I}_i$ and $v \notin \mathbf{I}_{i-1}$, both u and v are not in $\mathcal{R}(G, \mathbf{I})$, hence they must be vertices of G' . Therefore, $\mathcal{S}' = \langle \mathbf{I}_1 \setminus \mathcal{R}(G, \mathbf{I}), \mathbf{I}_2 \setminus \mathcal{R}(G, \mathbf{I}), \dots, \mathbf{J} \setminus \mathcal{R}(G, \mathbf{I}) \rangle$ is a TS-sequence in G' which reconfigures $\mathbf{I} \setminus \mathcal{R}(G, \mathbf{I}) = \mathbf{I} \cap G'$ to $\mathbf{J} \setminus \mathcal{R}(G, \mathbf{I}) = \mathbf{J} \cap G'$.

Assume that there exists a TS-sequence $\mathcal{S}' = \langle \mathbf{I}'_1 = \mathbf{I} \cap G', \mathbf{I}'_2, \dots, \mathbf{I}'_s = \mathbf{J} \cap G' \rangle$ in G' which reconfigures $\mathbf{I} \cap G'$ to $\mathbf{J} \cap G'$. By definition of G' , it follows that for any independent set \mathbf{I}' of G' , $\mathbf{I}' \cup \mathcal{R}(G, \mathbf{I})$ forms an independent set of G . Hence, $\mathcal{S} = \langle \mathbf{I}'_1 \cup \mathcal{R}(G, \mathbf{I}), \mathbf{I}'_2 \cup \mathcal{R}(G, \mathbf{I}), \dots, \mathbf{I}'_s \cup \mathcal{R}(G, \mathbf{I}) \rangle$ is a TS-sequence which reconfigures $\mathbf{I}'_1 \cup \mathcal{R}(G, \mathbf{I}) = \mathbf{I}$ to $\mathbf{I}'_s \cup \mathcal{R}(G, \mathbf{I}) = \mathbf{J}$.

We now show that $\mathcal{R}(G', \mathbf{I} \cap G') = \emptyset$. Let $v \in \mathbf{I} \cap G'$. Then, the token t_v placed at v is (G, \mathbf{I}) -movable, because otherwise $v \in \mathcal{R}(G, \mathbf{I})$. Hence, there exists a TS-sequence \mathcal{S} in G which slides t_v to a vertex $w \in N_G(v)$. Note that $w \in V(G')$. As before, from \mathcal{S} , one can construct a TS-sequence \mathcal{S}' in G' which slides t_v to w , hence implies t_v is $(G', \mathbf{I} \cap G')$ -movable. Therefore, $\mathcal{R}(G', \mathbf{I} \cap G') = \emptyset$. Similarly, one can also show that $\mathcal{R}(G', \mathbf{J} \cap G') = \emptyset$.

Suppose that $\mathcal{C}(G', \mathbf{I} \cap G') = \mathcal{C}(G', \mathbf{J} \cap G') \neq \emptyset$ and there exists a TS-sequence $\mathcal{S}' = \langle \mathbf{I}'_1 = \mathbf{I} \cap G', \mathbf{I}'_2, \dots, \mathbf{I}'_s = \mathbf{J} \cap G' \rangle$ in G' that reconfigures $\mathbf{I} \cap G'$ to $\mathbf{J} \cap G'$. For $j = 2, \dots, s$, let $u \in \mathbf{I}'_{j-1} \setminus \mathbf{I}'_j$ and $v \in \mathbf{I}'_j \setminus \mathbf{I}'_{j-1}$. Since all tokens in $\mathbf{I} \cap C$ are $(G', \mathbf{I} \cap G', V(C))$ -confined, u and v must be either both in G'' or both in some cycle $C \in \mathcal{C}(G', \mathbf{I} \cap G')$. Hence, $\mathcal{S}'' = \langle \mathbf{I}'_1 \cap G'' = \mathbf{I} \cap G'', \mathbf{I}'_2 \cap G'', \dots, \mathbf{I}'_s \cap G'' = \mathbf{J} \cap G'' \rangle$ is a TS-sequence in G'' which reconfigures $\mathbf{I} \cap G''$ to $\mathbf{J} \cap G''$.

Assume that there exists a TS-sequence $\mathcal{S}'' = \langle \mathbf{I}''_1 = \mathbf{I} \cap G'', \mathbf{I}''_2, \dots, \mathbf{I}''_t = \mathbf{J} \cap G'' \rangle$ in G'' which reconfigures $\mathbf{I} \cap G''$ to $\mathbf{J} \cap G''$. We claim that one can construct a TS-sequence \mathcal{S}' in G' which reconfigures $\mathbf{I} \cap G' = (\mathbf{I} \cap G'') \cup (\mathbf{I} \cap \mathcal{C}(G', \mathbf{I} \cap G'))$ to $\mathbf{J} \cap G' = (\mathbf{J} \cap G'') \cup (\mathbf{J} \cap \mathcal{C}(G', \mathbf{I} \cap G'))$. Note that for a given independent set \mathbf{I}'' of G'' and a cycle $C \in \mathcal{C}(G', \mathbf{I} \cap G')$, $\mathbf{I}'' \cup (\mathbf{I} \cap C)$ may not be an independent set of G' . The same observation holds for any independent set that is reconfigurable from \mathbf{I} . Let \mathcal{F} be the set of all components of G'' . From the previous part, one can construct a TS-sequence $\mathcal{S}''_F = \langle \mathbf{I}''_1 \cap F, \mathbf{I}''_2 \cap F, \dots, \mathbf{I}''_t \cap F \rangle$ for each component $F \in \mathcal{F}$. Let $A = \bigcup_{C \in \mathcal{C}(G', \mathbf{I} \cap G')} \bigcup_{x \in \mathbf{I} \cap C} (N_{G'}(x) \setminus V(C))$. For a given component F of G'' ,

■ If \mathcal{S}''_F involves no vertex in A .

For any independent set $\mathbf{I}_F \in \mathcal{S}''_F$ and any cycle C of G' , $\mathbf{I}_F \cup (\mathbf{I} \cap C)$ forms an independent set of G' . It follows that \mathcal{S}''_F can be “extended” to a TS-sequence in G' .

■ If \mathcal{S}''_F involves vertices in $A' = A \cap F$ (see Figure 7).

Let $C \in \mathcal{C}(G', \mathbf{I} \cap G')$. Since G' is a cactus, there is at most one vertex $v \in \mathbf{I} \cap C$ such that $N_{G'}(v) \cap V(F) \neq \emptyset$. Moreover, if there are two vertices $u_1, u_2 \in V(F)$ such that $N_{G'}(u_i) \cap V(C) \neq \emptyset$ ($i = 1, 2$) then they must both adjacent to v . By definition of $(G', \mathbf{I} \cap G', V(C))$ -confined tokens, for each such cycle C described above, there exists a TS-sequence $\mathcal{S}(C, v)$ which slides the token t_v at $v \in \mathbf{I} \cap C$ ($N_{G'}(v) \cap V(F) \neq \emptyset$) to some vertex w in $N_C(v)$. Now, if there are two of such cycle C , say C_1 and C_2 , let v_1 (resp. v_2) be a vertex in $\mathbf{I} \cap C_1$ (resp. $\mathbf{I} \cap C_2$) such that $N_{G'}(v_1) \cap V(F) \neq \emptyset$ (resp. $N_{G'}(v_2) \cap V(F) \neq \emptyset$). Since G is a cactus, $V(G_{C_1}^x) \cap V(G_{C_2}^y) = \emptyset$ for any $x \in V(C_1) \setminus \{v_1\}$ and $y \in V(C_2) \setminus \{v_2\}$. It follows that $\mathcal{S}(C_1, v_1)$ does not involve any vertex that is involved with $\mathcal{S}(C_2, v_2)$ and vice versa.

The TS-sequence \mathcal{S}' thus can be constructed as follows. First of all, we perform any sequence \mathcal{S}''_F that does not involve vertices of A . Next, for a component F such that \mathcal{S}''_F involves some vertex of A , let $C \in \mathcal{C}(G', \mathbf{I} \cap G')$ be such that there exists a vertex $v \in \mathbf{I} \cap C$ satisfying

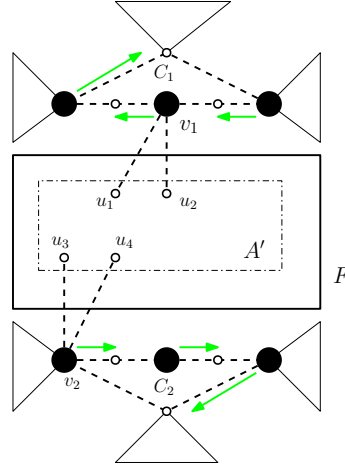

■ **Figure 7** \mathcal{S}''_F involves vertices in $A' \subseteq A$ (Lemma 13).

$N_G(v) \cap V(F) \subseteq A$. As observed before, such a vertex v is uniquely determined. Then, we perform $\mathcal{S}(C, v)$, then perform \mathcal{S}''_F , and then perform $\mathcal{S}(C, v)$ in reverse order. If the vertex $w \in N_G(v)$ where the token t_v is slid to after performing $\mathcal{S}(C, v)$ is also in \mathbf{J} then in the step of reversing $\mathcal{S}(C, v)$, we do not reverse the step of sliding t_v to w . At this moment, we have reconfigured $\mathbf{I} \cap G''$ to $\mathbf{J} \cap G''$ in G' . The remaining problem is to reconfigure $\mathbf{I} \cap C$ to $\mathbf{J} \cap C$ in G' for each cycle $C \in \mathcal{C}(G', \mathbf{I} \cap G')$, which can be done using Lemma 4 and the observation that for any vertex $v \in V(C)$, if $v \in \mathbf{J}$ then $N_G(v) \cap \mathbf{J} = \emptyset$.

Using a similar argument as before (based on the fact that if \mathbf{I}' is an independent set of G' then $\mathbf{I}' \cap G''$ is also an independent set of G''), one can show that $\mathcal{R}(G'', \mathbf{I} \cap G'') = \mathcal{R}(G'', \mathbf{J} \cap G'') = \emptyset$, and $\mathcal{C}(G'', \mathbf{I} \cap G'') = \mathcal{C}(G'', \mathbf{J} \cap G'') = \emptyset$. ◀

Proof of Lemma 14. First of all, we claim that if $N_{\mathcal{B}_w}(w) \cap \mathbf{I} = \emptyset$ then one can slide a closest token in G^* to w , where G^* is the graph obtained from G by removing all vertices in $\mathcal{B}_w - w$. In other words, there exists an independent set \mathbf{J} such that $\mathbf{I} \overset{G}{\rightsquigarrow} \mathbf{J}$ and $w \in \mathbf{J}$. If $w \in \mathbf{I}$ then we are done. Thus, assume that $w \notin \mathbf{I}$. Let $w' \in \mathbf{I} \cap G^*$ be such that $\text{dist}_{G^*}(w, w') = \min_{w'' \in \mathbf{I} \cap G^*} \text{dist}_{G^*}(w, w'')$. Let $P = w_1 \dots w_p$ ($p \geq 3$) be a shortest $w w'$ -path with $w_1 = w$ and $w_p = w'$. Let $M = N_{G^*}(w_{p-1}) \cap \mathbf{I}$. Since $N_{\mathcal{B}_w}(w) \cap \mathbf{I} = \emptyset$, it follows that $M = N_{G^*}(w_{p-1}) \cap \mathbf{I} = N_G(w_{p-1}) \cap \mathbf{I}$ for any $p \geq 3$. The definition of w' implies that no tokens are placed at $N_G[w_i]$ for $i = 1, 2, \dots, p-2$. We claim that a token on some vertex of M can be slid to w . If $|M| = 1$, i.e., M contains only w' , then one can slide (in G) the token on w' to w directly. If $|M| \geq 2$, then by Lemma 11, there exists at most one vertex z in M such that the token on z is $(G', \mathbf{I} \cap G')$ -rigid, where $G' = G - w_{p-1}$ (see Figure 8(a)). On the other hand, if there exists a cycle D containing w_{p-1} such that the path $Q = D - w_{p-1}$ is $(G', \mathbf{I} \cap G')$ -confined, then all tokens in M must be $(G', \mathbf{I} \cap G')$ -movable (see Figure 8(b)). Note that because $\mathcal{C}(G, \mathbf{I}) = \emptyset$, such a cycle D described above (if exists) must be unique. Also note that by Lemma 5 and the assumption that $\mathcal{R}(G, \mathbf{I}) = \emptyset$, both z and D cannot exist at the same time. If both of them do not exist, we can slide the token $t_{w'}$ placed at w' to w by first sliding all tokens in $M - w'$ (which are clearly $(G', \mathbf{I} \cap G')$ -movable) to some vertices in G' , and then slide $t_{w'}$ to w . If z exists, we first reduce the number of tokens in M by sliding all tokens in $M - z$ (which are clearly $(G', \mathbf{I} \cap G')$ -movable) to some vertices in G' , and then slide the token t_z on z to w . On the other hand, if D exists (uniquely), then one can slide a token $t_{z'}$ on $z' \in M \cap D$ to w by first sliding all tokens in $M - C$ (which

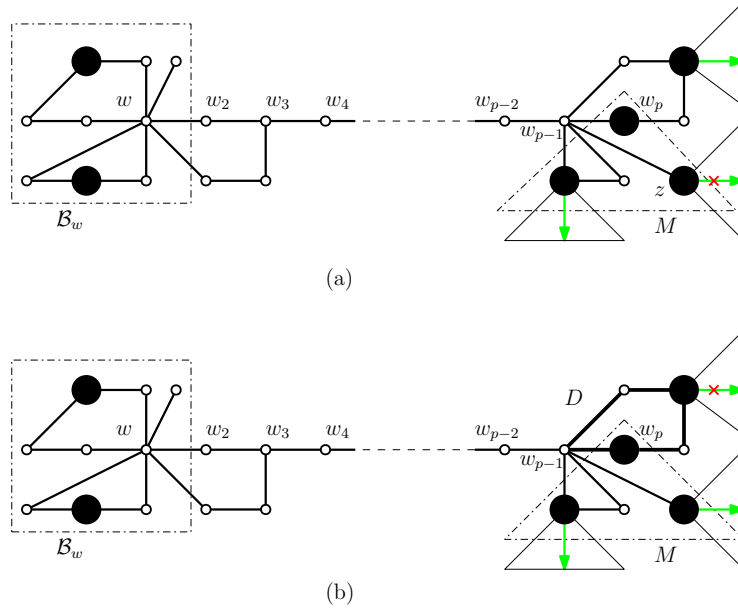

■ **Figure 8** (a) The token t_z at z is $(G', \mathbf{I} \cap G')$ -rigid; (b) The cycle D containing w_{p-1} such that the path $Q = D - w_{p-1}$ is $(G', \mathbf{I} \cap G')$ -confined.

are clearly $(G', \mathbf{I} \cap G')$ -confined) to some vertices in G' then sliding $t_{z'}$ to w_{p-1} (which, by Lemma 11, is the only way of moving $t_{z'}$ “out of” D), and finally to w .

Next, we estimate the maximum number of tokens that can be placed at vertices of \mathcal{B}_w . Observe that for any block $B \in \mathcal{B}_w$, since B is either K_2 or a cycle, $B - w$ is indeed a path. Moreover, the path $P = B - w$ satisfies that any token t_x placed at $x \in \mathbf{I} \cap P$ is $(G_P^x, \mathbf{I} \cap G_P^x, V(P))$ -confined, simply because in this case G_P^x is the graph contains a single vertex x . By Lemma 11, there is at most one block $B \in \mathcal{B}_w$ that contains $\lfloor |B|/2 \rfloor$ token(s), while all other blocks $B' \neq B$ must contain at most $\lfloor |B'|/2 \rfloor - 1$ token(s). Thus, $|\mathbf{I} \cap \mathcal{B}_w| \leq \sum_{B \in \mathcal{B}_w} (\lfloor |B|/2 \rfloor - 1) + 1$.

Finally, we claim that if $|\mathbf{I} \cap \mathcal{B}_w| \leq \sum_{B \in \mathcal{B}_w} (\lfloor |B|/2 \rfloor - 1)$, then one can “arrange” the tokens in $\mathbf{I} \cap \mathcal{B}_w$ such that there are no tokens placed at vertices of $N_{\mathcal{B}_w}[w]$. More formally, there exists an independent set \mathbf{J} such that $\mathbf{I} \overset{G}{\rightsquigarrow} \mathbf{J}$ and $N_{\mathcal{B}_w}[w] \cap \mathbf{J} = \emptyset$. If there exists a block $B \in \mathcal{B}_w$ such that $|\mathbf{I} \cap B| = \lfloor |B|/2 \rfloor$ then since $|\mathbf{I} \cap \mathcal{B}_w| \leq \sum_{B \in \mathcal{B}_w} (\lfloor |B|/2 \rfloor - 1)$, there must be another block $B' \in \mathcal{B}_w$ where $|B' \cap \mathbf{I}| < \lfloor |B'|/2 \rfloor - 1$. Since $\mathcal{R}(G, \mathbf{I}) = \emptyset$ and $\mathcal{C}(G, \mathbf{I}) = \emptyset$, one can slide a token from B to w (if there is no token at w) and then slide it to a vertex in B' . If there is a token at w , we slide it to a vertex in B' directly. Since at most one such block B exists, we can now assume that $|\mathbf{I} \cap B| \leq \lfloor |B|/2 \rfloor - 1$ for every block $B \in \mathcal{B}_w$. Clearly, a block $B \in \mathcal{B}_w$ contains a token only when $|B| \geq 4$, i.e., it is a cycle of length at least 4. Using Lemma 4 and note that all blocks $B \in \mathcal{B}_w$ are safe, one can easily obtain the described set \mathbf{J} .

Using the above claims, we now prove Lemma 14.

- (i) Assume that $\sum_{B \in \mathcal{B}_w} (\lfloor |B|/2 \rfloor - 1) = 0$. Since $|B| \geq 2$ for any block B of G , it follows that for all $B \in \mathcal{B}_w$, $2 \leq |B| \leq 3$, i.e., B is either K_2 or a cycle of length 3. Clearly, $N_{\mathcal{B}_w}(w) = V(\mathcal{B}_w) \setminus \{w\}$.

Now, for a safe vertex $v \in V(\mathcal{B}_w)$, one must have that $v \in N_{\mathcal{B}_w}(w) \subseteq N_G(w)$. If $v \in \mathbf{I}$ then we are done. Therefore, assume that $v \notin \mathbf{I}$. Note that in this case $|\mathbf{I} \cap \mathcal{B}_w| \leq 1$. If $|\mathbf{I} \cap \mathcal{B}_w| = 0$ then by the first claim above, one can slide a token to w , and then to v .

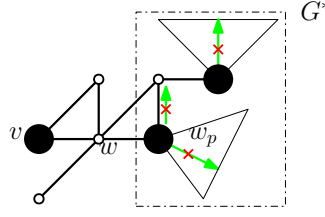

■ **Figure 9** Illustration of **Case (i)-1** of Lemma 15(i).

Otherwise, if $w \in \mathbf{I}$, then clearly the token placed at w can be slid to v . On the other hand, if there is a vertex $v' \notin \{v, w\}$ where $v' \in \mathbf{I} \cap \mathcal{B}_w$ then since $\mathcal{R}(G, \mathbf{I}) = \emptyset$ and $\mathcal{C}(G, \mathbf{I}) = \emptyset$, it follows that the token placed at v' can be slid to a vertex outside the block containing v' and w , therefore must be slid to w (which is the unique cut vertex of G in \mathcal{B}_w), and then can be slid to v from w .

- (ii) Assume that $\sum_{B \in \mathcal{B}_w} (\lfloor |B|/2 \rfloor - 1) \geq 1$. If $|\mathbf{I} \cap \mathcal{B}_w| = \sum_{B \in \mathcal{B}_w} (\lfloor |B|/2 \rfloor - 1)$ then we can just simply use the third claim to “arrange” the tokens in $\mathbf{I} \cap \mathcal{B}_w$.

If $|\mathbf{I} \cap \mathcal{B}_w| = \sum_{B \in \mathcal{B}_w} (\lfloor |B|/2 \rfloor - 1) + 1$ then there must exist a unique token t in $N_{\mathcal{B}_w}[w]$ which cannot be “arranged” using the third claim. Note that in this case $|\mathbf{I} \cap (\mathcal{B}_w - w)| = \sum_{B \in \mathcal{B}_w} (\lfloor |B|/2 \rfloor - 1)$. If t is placed at w then $N_{\mathcal{B}_w}(w) \cap \mathbf{I} = \emptyset$ and we are done. If t is placed at some vertex in $N_{\mathcal{B}_w}(w)$ then it can be slid to w because $\mathcal{R}(G, \mathbf{I}) = \emptyset$ and $\mathcal{C}(G, \mathbf{I}) = \emptyset$. By sliding t to w , there is now no token placed at any vertex in $N_{\mathcal{B}_w}(w)$, and the resulting independent set is the set \mathbf{I}' we need.

Hence, we can assume that $|\mathbf{I} \cap \mathcal{B}_w| < \sum_{B \in \mathcal{B}_w} (\lfloor |B|/2 \rfloor - 1)$. We claim that one can construct an independent set \mathbf{I}' such that $\mathbf{I} \stackrel{G}{\rightsquigarrow} \mathbf{I}'$, $N_{\mathcal{B}_w}(w) \cap \mathbf{I}' = \emptyset$, and $|\mathbf{I}' \cap (\mathcal{B}_w - w)| = \sum_{B \in \mathcal{B}_w} (\lfloor |B|/2 \rfloor - 1)$. Using the third claim, we can assume without loss of generality that $N_{\mathcal{B}_w}[w] \cap \mathbf{I} = \emptyset$. We construct the set \mathbf{I}' using TS rule as follows. While the number of tokens in $\mathcal{B}_w - w$ is smaller than $\sum_{B \in \mathcal{B}_w} (\lfloor |B|/2 \rfloor - 1)$, we use the first claim to move some token t not in $\mathcal{B}_w - w$ to w , then move t to some block $B \in \mathcal{B}_w$ which contains less than $\lfloor |B|/2 \rfloor - 1$ token(s), then using the third claim to “arrange” the set of tokens in \mathcal{B}_w so that $N_{\mathcal{B}_w}[w]$ contains no token. Repeat the above steps until the number of tokens in \mathcal{B}_w is equal to $\sum_{B \in \mathcal{B}_w} (\lfloor |B|/2 \rfloor - 1)$, we finally obtain \mathbf{I}' . ◀

Proof of Lemma 15.

- (i) First of all, we claim that $\mathcal{R}(G^*, \mathbf{I}^*) = \emptyset$. Assume for the contradiction that $\mathcal{R}(G^*, \mathbf{I}^*) \neq \emptyset$. Let $w' \in \mathbf{I}^*$ be a vertex where a (G^*, \mathbf{I}^*) -rigid token is placed. Let $P = w_1 w_2 \dots w_p$ be a vw' -path with $w_1 = v$, $w_2 = w$ and $w_p = w'$.

Case (i)-1: $w_{p-1} = w$. (See Figure 9)

In this case, it is clear that $\text{dist}_G(w, w_p) = 1$. From Lemma 14, any block $B \in \mathcal{B}_w$ is either K_2 or a cycle of length 3. Let B be the safe block containing v . If B is K_2 then clearly the token t_v placed at v is $(G - w, \mathbf{I} \cap (G - w))$ -rigid. On the other hand, if B is a cycle of length 3 then the path $B - w$ is clearly $(G - w, \mathbf{I} \cap (G - w))$ -confined. By Lemma 11, in any of these two cases, the token t_{w_p} placed at $w_p = w_3 \in N_G(w)$ must be $(G - w, \mathbf{I} \cap (G - w))$ -movable. By definition, G^* is indeed a connected component of $G - w$ and $\mathbf{I}^* = \mathbf{I} \cap G^* = (\mathbf{I} - v) \cap (G - w)$. Hence, t_{w_p} must be $(G^*, \mathbf{I} \cap G^*)$ -movable, which is a contradiction.

Case (i)-2: $w_{p-2} = w$. (See Figure 10.) In this case, we can assume that any (G^*, \mathbf{I}^*) -rigid token is of distance (in G) at least 2 from w (which then implies $\text{dist}_G(w, w_p) = 2$

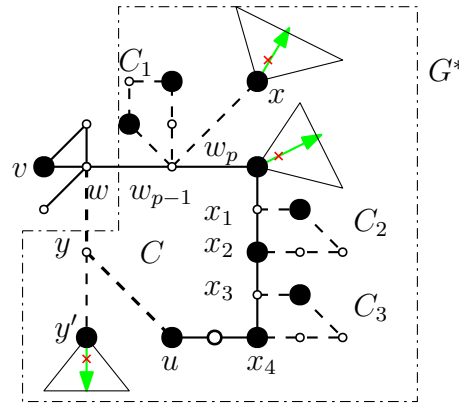

■ **Figure 10** Illustration of **Case (i)-2** of Lemma 15(i).

in this case) since if otherwise then we back to **Case i-(1)** and claim that there must be some contradiction.

Suppose that there exists a cycle C_1 in G^* such that $w_{p-1} \in V(C_1)$, $w_p \notin V(C_1)$, and the path $P_1 = C_1 - w_{p-1}$ is $(G^* - N_{G^*}[w_p], \mathbf{I}^* \cap (G^* - N_{G^*}[w_p]))$ -confined. Let $H(G^* - N_{G^*}[w_p], P_1)$ be the component of $G^* - N_{G^*}[w_p]$ containing P_1 . Since G is a cactus, it follows that $N_G(w) \cap H(G^* - N_{G^*}[w_p], P_1) = \emptyset$. Hence, $H(G^* - N_{G^*}[w_p], P_1)$ must also be a component of $G - N_G[w_p]$. Therefore, C_1 satisfies that $w_{p-1} \in V(C_1)$, $w_p \notin V(C_1)$, and the path $P_1 = C_1 - w_{p-1}$ is $(G - N_G[w_p], \mathbf{I} \cap (G - N_G[w_p]))$ -confined. It follows that the token t_{w_p} placed at w_p cannot be slid in G to w_{p-1} . Note that Lemma 11 implies that C_1 is uniquely determined. Since t_{w_p} is (G, \mathbf{I}) -movable, it follows that there exists a vertex $x_1 \in N_G(w_p) \setminus \{w_{p-1}\}$ such that t_{w_p} can be slid in G to x_1 . Since t_{w_p} is (G^*, \mathbf{I}^*) -rigid, it follows that $(N_{G^*}(x_1) \setminus \{w_p\}) \cap \mathbf{I}^* = (N_G(x_1) \setminus \{w_p\}) \cap \mathbf{I} \neq \emptyset$.

Let $x_2 \in N_{G^*}(x_1) \setminus \{w_p\} \cap \mathbf{I}^*$. Now, if there exists a cycle C_2 in G^* such that $\{x_1, x_2\} \subseteq V(C_2)$, $w_p \notin V(C_2)$, and the path $P_2 = C_2 - x_1$ is $(G^* - N_{G^*}[w_p], \mathbf{I}^* \cap (G^* - N_{G^*}[w_p]))$ -confined, then using the same argument as with P_1 , it follows that t_{w_p} cannot be slid in G to x_1 , which contradicts our assumption. Therefore, for any $x_2 \in N_{G^*}(x_1) \setminus \{w_p\} \cap \mathbf{I}^*$, such a cycle C_2 does not exist.

Hence, there must be some $x_2 \in N_{G^*}(x_1) \setminus \{w_p\} \cap \mathbf{I}^*$ such that the token t_{x_2} placed at x_2 must be $(G^* - N_{G^*}[w_p], \mathbf{I}^* \cap (G^* - N_{G^*}[w_p]))$ -rigid, and hence also (G^*, \mathbf{I}^*) -rigid since t_{w_p} is also (G^*, \mathbf{I}^*) -rigid. On the other hand, since t_{x_2} is (G, \mathbf{I}) -movable, it follows that the component $H(G^* - N_{G^*}[w_p], x_2)$ of $G^* - N_{G^*}[w_p]$ containing x_2 must not be a component of $G - N_G[w_p]$, which then implies that $w \in V(H(G - N_G[w_p], x_2))$, where $H(G - N_G[w_p], x_2)$ is the component of $G - N_G[w_p]$ containing x_2 . Hence, there exists a cycle C in G containing w, w_{p-1}, w_p, x_1 and x_2 . As G is a cactus, the cycle C is unique.

Let $x_3 \neq x_1$ be another neighbor of x_2 in C . Using a similar argument as with C_1 , one can show that there does not exist any cycle C_3 in G^* such that $x_3 \in V(C_3)$, $x_2 \notin V(C_3)$, and the path $P_3 = C_3 - x_3$ is $(G^* - N_{G^*}[y], \mathbf{I}^* \cap (G^* - N_{G^*}[x_2]))$ -confined. Note that in such cycle C_3 described above, $V(C_3) \cap V(C) = \{x_3\}$. Hence, there must be some $x_4 \in (N_{G^*}(x_3) \setminus \{x_2\}) \cap \mathbf{I}^*$ such that the token t_{x_4} placed at x_4 is $(G^* - N_{G^*}[x_2], \mathbf{I}^* \cap (G^* - N_{G^*}[x_2]))$ -rigid, and hence (G^*, \mathbf{I}^*) -rigid as t_{x_2} is also (G^*, \mathbf{I}^*) -rigid. On the other hand, since t_{x_4} is (G, \mathbf{I}) -movable, it follows that the component $H(G^* - N_{G^*}[x_2], x_4)$ of $G^* - N_{G^*}[x_2]$ containing x_4 must not be

a component of $G - N_G[x_2]$, which then implies that $w \in V(H(G - N_G[x_2], x_4))$, where $H(G - N_G[x_2], x_4)$ is the component of $G - N_G[x_2]$ containing x_4 . Since G is a cactus, it must happen that $x_4 \in V(C)$. Repeat the arguments with vertices of C , we finally obtain that there must be some (G^*, \mathbf{I}^*) -rigid token placed at a vertex $u \in V(C)$ of distance 1 or 2 from w (in G). Since $\text{dist}_G(w, w_p) = 2$ and t_{w_p} is a closest (G^*, \mathbf{I}^*) -rigid token to w , no (G^*, \mathbf{I}^*) -rigid token can be placed at some vertex of distance 1 from w . Thus, $\text{dist}_G(w, u) = 2$.

Hence, without loss of generality, we now can assume that there does not exist any cycle C_1 in G^* such that $w_{p-1} \in V(C_1)$, $w_p \notin V(C_1)$, and the path $P_1 = C_1 - w_{p-1}$ is $(G^* - N_{G^*}[w_p], \mathbf{I}^* \cap (G^* - N_{G^*}[w_p]))$ -confined (if such cycle C_1 exists, then find such vertex u described above and regard it as w_p). Since t_{w_p} is (G^*, \mathbf{I}^*) -rigid, there must be some vertex $x \in (N_{G^*}(w_{p-1}) \setminus \{w_p\}) \cap \mathbf{I}^*$ such that the token t_x placed at x is $(G^* - N_{G^*}[w_p], \mathbf{I}^* \cap (G^* - N_{G^*}[w_p]))$ -rigid, and hence also (G^*, \mathbf{I}^*) -rigid as t_{w_p} is (G^*, \mathbf{I}^*) -rigid. Thus, both t_{w_p} and t_x are $(G^* - w_{p-1}, \mathbf{I}^* \cap (G^* - w_{p-1}))$ -rigid. Since all tokens in \mathbf{I} are (G, \mathbf{I}) -movable and $w_{p-1} \notin \mathbf{I}$, by Lemma 11, it follows that at most one of the two tokens t_{w_p} and t_x is $(G - w_{p-1}, \mathbf{I} \cap (G - w_{p-1}))$ -rigid. Without loss of generality, assume t_{w_p} is not $(G - w_{p-1}, \mathbf{I} \cap (G - w_{p-1}))$ -rigid. Hence, it must happen that $w \in V(H(G - w_{p-1}, w_p))$, where $H(G - w_{p-1}, w_p)$ is the component of $G - w_{p-1}$ containing w_p . Thus, there exists a (unique) cycle C in G containing w and w_p . Now, let $H(G^* - w_{p-1}, x)$ and $H(G^* - w_{p-1}, w_p)$ be the components of $G^* - w_{p-1}$ containing x and w_p , respectively. As $H(G^* - w_{p-1}, w_p)$ is not a component of $G - w_{p-1}$, it follows that $H(G^* - w_{p-1}, x)$ is a component of $G - w_{p-1}$, that is, $H(G^* - w_{p-1}, x) = H(G - w_{p-1}, x)$ because if otherwise, $w \in V(H(G - w_{p-1}, x))$, which contradicts to the fact that G is a cactus. Hence, t_x is indeed $(G - w_{p-1}, \mathbf{I} \cap (G - w_{p-1}))$ -rigid, which means that t_{w_p} cannot be slid in G to w_{p-1} .

Let $x_1 \in N_G(w_p) \setminus \{w_{p-1}\}$ be a neighbor of w_p such that t_{w_p} can be slid in G to x_1 . If $x_1 \notin V(C)$ then since t_{w_p} is (G^*, \mathbf{I}^*) -rigid and (G, \mathbf{I}) -movable, it must happen that $w \in H(G - w_p, x_1)$, which is a contradiction as G is a cactus. Hence, $x_1 \in V(C)$. As before, one can show that there exists a vertex $x_2 \in (N_{G^*}(x_1) \setminus \{w_p\}) \cap \mathbf{I}^*$ which is (G^*, \mathbf{I}^*) -rigid and (G, \mathbf{I}) -movable, and hence must be in $V(C)$. Repeat the arguments, we finally obtain that there must be some (G^*, \mathbf{I}^*) -rigid token placed at some vertex in $V(C)$ of distance 2 (in G) from w , say u , which is different from w_p and x . Now, let y be the common neighbor of w and u . As the token t_u placed at u is (G^*, \mathbf{I}^*) -rigid, there exists some vertex $y' \in (N_{G^*}(y) \setminus \{u\}) \cap \mathbf{I}^*$ such that the token $t_{y'}$ placed at y' is $(G^* - N_{G^*}[u], \mathbf{I}^* \cap (G^* - N_{G^*}[u]))$ -rigid, and hence (G^*, \mathbf{I}^*) -rigid as t_u is (G^*, \mathbf{I}^*) -rigid. Let $H(G^* - N_{G^*}[u], y')$ be the component of $G^* - N_{G^*}[u]$ containing y' . Since $t_{y'}$ is (G, \mathbf{I}) -movable, $H(G^* - N_{G^*}[u], y')$ is not a component of $G - N_G[u]$, which means that $w \in H(G - N_G[u], y')$. But this is a contradiction as G is a cactus.

Case (i)-3: $w_{p-1} \neq w$ and $w_{p-2} \neq w$. (See Figure 11.)

As before, one can assume that any (G^*, \mathbf{I}^*) -rigid token is of distance (in G) at least 3 from w . Assume that there exists a cycle C_1 such that $w_{p-1} \in V(C_1)$, $w_p \notin V(C_1)$, $w_{p-2} \notin V(C_1)$, and the path $P_1 = C_1 - w_{p-1}$ is $(G^* - N_{G^*}[w_p], \mathbf{I}^* \cap (G^* - N_{G^*}[w_p]))$ -confined. As in **Case (i)-2**, one can show that there must be a (G^*, \mathbf{I}^*) -rigid token placed at some vertex of distance 1 or 2 (in G) from w , which then leads to a contradiction. Hence, such a cycle C_1 does not exist.

Now, consider a (unique) cycle C_2 such that $\{w_{p-1}, w_{p-2}\} \subseteq V(C_2)$, $w_p \notin V(C_2)$, and the path $P_2 = C_2 - w_{p-1}$ is $(G^* - N_{G^*}[w_p], \mathbf{I}^* \cap (G^* - N_{G^*}[w_p]))$ -confined.

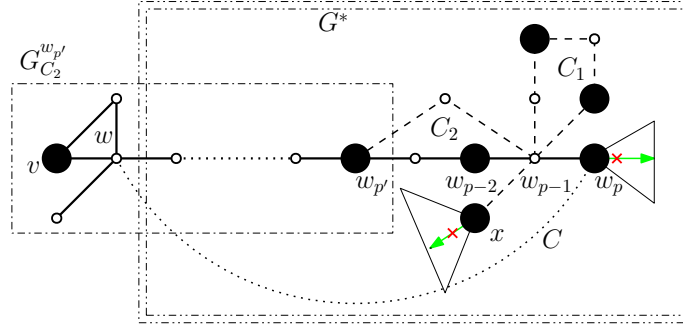

■ **Figure 11** Illustration of **Case (i)-3** of Lemma 15(i).

First, assume that it does not exist. Since t_{w_p} is (G^*, \mathbf{I}^*) -rigid, there must be some vertex $x \in (N_{G^*}(w_{p-1}) \setminus \{w_p\}) \cap \mathbf{I}^*$ such that the token t_x placed at x is $(G^* - N_{G^*}[w_p], \mathbf{I}^* \cap (G^* - N_{G^*}[w_p]))$ -rigid, and hence also (G^*, \mathbf{I}^*) -rigid as t_{w_p} is (G^*, \mathbf{I}^*) -rigid. As before, at most one of the two tokens t_{w_p} and t_x is $(G - w_{p-1}, \mathbf{I} \cap (G - w_{p-1}))$ -rigid. Without loss of generality, assume that t_{w_p} is not $(G - w_{p-1}, \mathbf{I} \cap (G - w_{p-1}))$ -rigid. Hence, it must happen that $w \in V(H(G - w_{p-1}, w_p))$, where $H(G - w_{p-1}, w_p)$ is the component of $G - w_{p-1}$ containing w_p . Thus, there exists a (unique) cycle C in G containing w and w_p . Using a similar argument as in the previous part, one can show that this will lead to a contradiction.

Therefore, such a cycle C_2 described above must exist. Let p' be the smallest index ($1 \leq p' \leq p-1$) such that $w_{p'} \in V(C_2) \cap V(P)$. Using Lemma 8 and the fact that for any $x \in V(C_2) \setminus \{w_{p'}\}$, $G_{C_2}^{*x} = G_{C_2}^x$ (i.e., $w \in G_{C_2}^{w_{p'}}$), we can thus assume that $w_{p'} \in \mathbf{I}$ and the token $t_{w_{p'}}$ placed at $w_{p'}$ is $(G_{C_2}^{*w_{p'}}, \mathbf{I}^* \cap G_{C_2}^{*w_{p'}})$ -rigid and $(G_{C_2}^{w_{p'}}, \mathbf{I} \cap G_{C_2}^{w_{p'}})$ -movable. Replace G by $G_{C_2}^{w_{p'}}$, the independent set \mathbf{I} by $\mathbf{I} \cap G_{C_2}^{w_{p'}}$, and w_p by $w_{p'}$ in the previous arguments, one can then either obtain a contradiction (when $\text{dist}_G(w, w_{p'}) \leq 2$) or repeat the arguments once more time (when $\text{dist}_G(w, w_{p'}) \geq 3$). Hence, we can now conclude that $\mathcal{R}(G^*, \mathbf{I}^*) = \emptyset$.

Next, we claim that $\mathcal{C}(G^*, \mathbf{I}^*) = \emptyset$. Assume that it is not empty, i.e., there exists a cycle $C^* \in \mathcal{C}(G^*, \mathbf{I}^*)$. Note that C^* is also a cycle of G , and $\mathbf{I} \cap C^* = \mathbf{I}^* \cap C^*$, which means that $\mathbf{I} \cap C^*$ is also a maximum independent set of C^* . Without loss of generality, using Lemma 8, we can assume that there is some token t_x placed at a vertex $x \in \mathbf{I} \cap C^*$ such that t_x is $(G_{C^*}^x, \mathbf{I} \cap G_{C^*}^x)$ -movable but $(G_{C^*}^{*x}, \mathbf{I}^* \cap G_{C^*}^{*x})$ -rigid. It follows that $w \in V(G_{C^*}^x)$. Since any TS-sequence in $G_{C^*}^x$ can indeed be extended to a TS-sequence in G (see the proof of Lemma 1), it follows that $\mathcal{R}(G_{C^*}^x, \mathbf{I} \cap G_{C^*}^x) = \emptyset$. Additionally, using the previous part, one can show that the removal of vertices in \mathcal{B}_w from $G_{C^*}^x$ does not result any new rigid token in the obtained graph $G_{C^*}^{*x}$, which clearly contradicts the assumption that t_x is $(G_{C^*}^{*x}, \mathbf{I}^* \cap G_{C^*}^{*x})$ -rigid.

- (ii) We first claim that $\mathcal{R}(G^*, \mathbf{I}^*) = \emptyset$. Assume for the contradiction that $\mathcal{R}(G^*, \mathbf{I}^*) \neq \emptyset$. Let $w' \in \mathbf{I}^*$ be a vertex where a (G^*, \mathbf{I}^*) -rigid token is placed. Let $Q = w_1 w_2 \dots w_q$ be a ww' -path with $w_1 = w$ and $w_q = w'$ ($q \geq 1$).

Case (ii)-1: $w_q = w$. First, assume that $N_{\mathcal{B}_w}(w) \subseteq N_G[\mathbf{I} \cap (\mathcal{B}_w - w)]$. Also note that in this case $|\mathbf{I} \cap \mathcal{B}_w| = \sum_{B \in \mathcal{B}_w} (\lfloor |B|/2 \rfloor - 1) + 1$. It follows that the token t_w placed at w cannot be slid (in G) to any vertex in $N_{\mathcal{B}_w}(w)$. Let $\mathcal{S} = \langle \mathbf{I}_1 = \mathbf{I}, \mathbf{I}_2, \dots, \mathbf{I}_\ell \rangle$ be a TS-sequence which slides t_w to some vertex in $N_{G^*}(w)$. Since w is the unique cut vertex in \mathcal{B}_w and $|\mathbf{I} \cap \mathcal{B}_w|$ is maximum, \mathcal{S} does not involve any vertex in $\mathbf{I} \cap (\mathcal{B}_w - w)$, i.e., for any

$\mathbf{J} \in \mathcal{S}$, $(\mathbf{I} \cap (\mathcal{B}_w - w)) \subseteq \mathbf{J}$. (Roughly speaking, no token in \mathcal{B}_w can “move out” while t_w “stay” in w). Hence, $\mathcal{S}' = \langle \mathbf{I}_1 \setminus (\mathbf{I} \cap (\mathcal{B}_w - w)), \mathbf{I}_2 \setminus (\mathbf{I} \cap (\mathcal{B}_w - w)), \dots, \mathbf{I}_\ell \setminus (\mathbf{I} \cap (\mathcal{B}_w - w)) \rangle$ is a TS-sequence in G^* which slides t_w to a vertex in $N_{G^*}(w)$, which is clearly a contradiction. Hence, $N_{\mathcal{B}_w}(w) \subsetneq N_G[\mathbf{I} \cap (\mathcal{B}_w - w)]$. It follows that there exists some vertex $x \in N_{\mathcal{B}_w}(w) \cap V(G^*)$. From the definition of G^* and $\mathbf{I} \cap N_{\mathcal{B}_w}(w) = \emptyset$, we must have $N_{G^*}(x) \cap \mathbf{I} = \{w\}$, i.e., t_w can be directly slid to x in G^* , which is a contradiction.

Case (ii)-2: $w_{q-1} = w$. Without loss of generality, we assume that no (G^*, \mathbf{I}^*) -rigid token is placed at w . Assume that there exists a cycle C_1 in G^* such that $w_q \notin V(C_1)$, $w_{q-1} \in V(C_1)$, and the path $P_1 = C_1 - w_{q-1}$ is $(G^* - N_{G^*}[w_q], \mathbf{I} \cap (G^* - N_{G^*}[w_q]))$ -confined. Let $H(G^* - N_{G^*}[w_q], P_1)$ be the component of $G^* - N_{G^*}[w_q]$ containing P_1 . Since all vertices in $N_G[\mathbf{I} \cap (\mathcal{B}_w - w)]$ are non-cut, $H(G^* - N_{G^*}[w_q], P_1)$ is also a component of $G - N_G[w_q]$, i.e., the token t_{w_q} placed at w_q cannot be slid to w in G . Using a similar argument as in case **(i)-2**, one can indeed assume that such cycle C_1 does not exist and then derive some contradiction.

Case (ii)-3: $w_{q-2} = w$. Similar as in **Case (i)-3**, one can argue that there does not exist any cycle C_1 such that $w_{q-1} \in V(C_1)$, $w_q \notin V(C_1)$, $w_{q-2} \notin V(C_1)$, and the path $P_1 = C_1 - w_{q-1}$ is $(G^* - N_{G^*}[w_q], \mathbf{I} \cap (G^* - N_{G^*}[w_q]))$ -confined. On the other hand, there must be some C_2 with $\{w_{q-1}, w_{q-2}\} \subseteq V(C_2)$, $w_q \notin V(C_2)$ and the path $P_2 = C_2 - w_{q-1}$ is $(G^* - N_{G^*}[w_q], \mathbf{I} \cap (G^* - N_{G^*}[w_q]))$ -confined. As in **Case (i)-3**, we assume that $\mathcal{R}(G_{C_2}^w, \mathbf{I} \cap G_{C_2}^w) = \emptyset$ and argue with the triple $(G_{C_2}^w, \mathbf{I} \cap G_{C_2}^w, w)$ instead of (G, \mathbf{I}, w_q) and immediately derive the contradiction because of **Case (ii)-1**.

Case (ii)-4: $w_{q-1} \neq w$ and $w_{q-2} \neq w$. One can use a similar argument as in **Case (i)-3** to claim that some contradiction must happen.

Using a similar argument as in part (i), one can also show that $\mathcal{C}(G^*, \mathbf{I}^*) = \emptyset$. ◀

Proof of Lemma 16. The only-if-part is trivial. We claim the if-part, i.e., if $|\mathbf{I}| = |\mathbf{J}|$ then $\mathbf{I} \overset{G}{\leftrightarrow} \mathbf{J}$. In order to show this, we claim that there is some independent set \mathbf{I}^* such that $\mathbf{I} \overset{G}{\leftrightarrow} \mathbf{I}^*$ and $\mathbf{J} \overset{G}{\leftrightarrow} \mathbf{I}^*$. The following algorithm constructs such \mathbf{I}^* . Initially, $\mathbf{I}^* = \emptyset$.

- Pick a cut vertex w with $\mathcal{B}_w \neq \emptyset$.
- If $\sum_{B \in \mathcal{B}_w} (\lfloor |B|/2 \rfloor - 1) = 0$, pick a safe vertex $v \in V(\mathcal{B}_w)$, using Lemma 14(i), slide a token in \mathbf{I} and a token in \mathbf{J} to v . Let $\mathbf{I}' = \mathbf{I} \setminus \{v\}$ and $\mathbf{J}' = \mathbf{J} \setminus \{v\}$. Add v to \mathbf{I}^* . Remove all vertices in \mathcal{B}_w and let G' be the resulting graph.
- If $\sum_{B \in \mathcal{B}_w} (\lfloor |B|/2 \rfloor - 1) \geq 1$, using Lemma 14(ii), slide tokens of \mathbf{I} and tokens of \mathbf{J} to the vertices in \mathcal{B}_w . Using Lemma 4, for each block $B \in \mathcal{B}_w$, exhaustively place the tokens at the vertices $v_2[B], v_4[B], \dots$. Let $\mathbf{I}' = \mathbf{I} \setminus (\mathcal{B}_w - w)$ and $\mathbf{J}' = \mathbf{J} \setminus (\mathcal{B}_w - w)$. Add the vertices in \mathcal{B}_w where tokens are placed to \mathbf{I}^* . Remove all vertices in $N_G[\mathbf{I}^* \cap (\mathcal{B}_w - w)]$. Let G' be the resulting graph.
- Repeat the above steps with the new triple $(G', \mathbf{I}', \mathbf{J}')$. The algorithm stops when there are no tokens to move.

The correctness of this algorithm is followed from Lemma 14 and Lemma 15. ◀